



AirMax2

802.11g Outdoor CPE

User's Manual





Copyright & Disclaimer

No part of this publication may be reproduced in any form or by any means, whether electronic, mechanical, photocopying, or recording without the written consent of OvisLink Corp.

OvisLink Corp. has made the best effort to ensure the accuracy of the information in this user's guide. However, we are not liable for the inaccuracies or errors in this guide. Please use with caution. All information is subject to change without notice

All Trademarks are properties of their respective holders.



© 2009 OvisLink Corporation, All Rights Reserved

Table of Contents

1. Introduction	1
1.1 Overview	1
1.2 Firmware Upgrade and Tech Support	1
1.3 Features	2
1.4 Wireless Operation Modes.....	2
1.4.1 Access Point Mode.....	3
1.4.2 Client Mode	3
1.4.3 Bridge Mode	4
1.4.4 WDS Repeater Mode	4
1.4.5 Universal Repeater Mode	5
1.4.6 WISP Router Mode	5
1.4.7 WISP + Repeater Mode	6
1.4.8 AP Router Mode.....	7
1.4.9 WDS Station(Bridge Send Beacon).....	7
2. Installing the AirMax2	8
2.1 Before You Start	8
2.2 Package Content	9
2.3 Optional Accessories	9
2.4 Knowing Your AirMax2	10
2.5 Hardware Installation	11
2.5.1 Standard Pole Mount.....	13
2.5.2 Optional Tilting Metal Pole/ Wall Mount	14
2.5.3 Installing External Antenna.....	16
2.6 LED Table	18
2.7 Restore Settings to Default	18
3. Configuring the AirMax2	19
3.1 Important Information.....	19
3.2 Prepare your PC	19
3.3 Management Interface	20
Web Management (HTTP):.....	20
Secured Web Management (HTTPS):.....	21
Command Line Interface (Telnet):.....	21
Secure Shell (SSH, SSH2)	22
3.4 Introduction to Web Management.....	23

3.4.1 Main Menu.....	24
3.5 Initial Configurations	25
3.5.1 Changing the Regulatory Domain	25
3.5.2 Change the Device’s IP Address	25
3.5.3 Set the Time and Date	26
3.5.4 Enable/Disable Telnet and SSH Management	27
3.5.5 Change Password	27
4. Wireless Settings	28
4.1 About Wireless Modes	28
4.2 General Wireless Functions.....	30
4.2.1 Regulatory Domain.....	30
4.2.2 Network SSID	31
4.2.3 Site Survey	31
4.2.4 Signal Survey	32
4.2.5 Hide SSID	32
4.2.6 Radio Mode.....	32
4.2.7 Channel	33
4.2.8 Client Mode Security Settings	33
4.2.9 AP Mode Security Settings	35
4.2.10 Client Isolation.....	38
4.2.11 Data Rate.....	38
4.2.12 Tx Output Power.....	38
4.2.13 Clear Signal Technology	39
4.2.14 Antenna Select	39
4.2.15 Auto Clone MAC (Client Mode Only)	39
4.2.16 Manual MAC Clone (Client Mode Only).....	39
4.2.17 Access Control	39
4.3 LED Threshold	40
4.4 Advance Settings	41
4.5 Bridge Mode Settings.....	43
4.5.1 WDS Settings.....	43
4.5.2 WDS Security	43
5. Wireless Menu: Router Mode Settings.....	46
5.1 Router Mode Settings under Wireless Menu	46
5.1.1 WAN Port.....	47
5.1.2 Virtual Server Settings	47
5.1.2 DMZ.....	48
5.1.3 Dynamic DNS	48
5.1.4 DoS (Denial of Service).....	49
5.1.5 URL Filter	50
5.1.6 MAC Filter.....	50
5.1.7 IP Filter	50

5.1.8 Special Applications.....	51
5.1.9 Diagnostic (DNS Lookup)	51
5.1.10 PING	52
5.1.11 Remote Management	52
6. System Configurations.....	53
6.1 Menu Structure	53
6.2 LAN Interface Setup	53
6.2.1 DHCP Settings	54
6.2.2 Clone MAC Address	54
6.2.3 Disable PING	54
6.2.4 Add DHCP Static Lease Client	55
6.3 Time Settings	55
6.4 Password Settings	56
6.5 System Management.....	56
6.6 Watchdog.....	57
6.7 Firmware Upgrade	57
6.8 Configuration Save and Restore.....	58
6.9 Factory Default	59
7. Device Status Menu	60
7.1 Menu Structure	60
7.2 Device Information	60
7.3 Statistic	61
7.4 Client Table	62
7.5 Log.....	62
8. Bandwidth Control	63
8.1 What is Bandwidth Control?.....	63
8.2 Type of Bandwidth Control.....	63
8.2.1 Interface Control	63
8.2.2 Individual IP/MAC Control	64
8.3 What is “Out Rate”?	64
8.4 Configure the Bandwidth Control	65
8.4.1 Interface Control Settings	67
8.4.2 Define Policy	67
8.4.3 Control by IP Address	68
8.4.4 Control by MAC Address	69

9. Command Line Interface	71
9.1 Available Commands	71
10. Emergency Firmware Recovery	79
10.1 How Emergency Upgrade Works?	79
10.2 Emergency Upgrade Procedure	79
11. Frequent Asked Questions	81
12. Specifications.....	84
12.1 Hardware Features	84
12.1.1 General Hardware Feature	84
12.1.2 Antenna	84
12.1.3 Power Supply	84
12.1.4 Dimension and Weight.....	85
12.2 Radio Specifications	85
12.2.1 Frequency Band	85
12.2.3 Rate and Modulation.....	85
12.2.4 TX Output Power	85
12.2.5 Receiver Sensitivity	85
12.2.6 Supported WLAN Mode.....	86
12.3 Software Feature	86
12.3.1 Operation Mode	86
12.3.2 Management Interface	86
13. Wireless Network Glossary.....	87

1

Introduction

1.1 Overview

The AIRMAX2 is a wireless outdoor multi-function device based on IEEE 802.11g/b 2.4GHz radio technologies. When installed in upright position, it is rain and splash proof. It features an integrated 10dBi patch antenna and passive POE to simplify the installation. The built-in antenna can provide up to 3km* of distance depending on conditions. If more distance is required, a R-SMA antenna connector is available for external antenna. The firmware of the AP provides up to 9 operation modes* to satisfy different application environments.

1.2 Firmware Upgrade and Tech Support

If you encounter a technical issue that can not be resolved by information on this guide, we recommend that you visit our comprehensive website support at www.airlive.com. The tech support FAQ are frequently updated with latest information.

In addition, you might find new firmwares that either increase software functions or provide bug fixes for AirMax2. You can reach our on-line support center at the following link: http://www.airlive.com/support/support_2.jsp

Since 2009, AirLive has added the “Newsletter Instant Support System” on our website. AirLive Newsletter subscribers receives instant email notifications when there are new download or tech support FAQ updates for their subscribed airlive models. To become an AirLive newsletter member, please visit: http://www.airlive.com/member/member_3.jsp

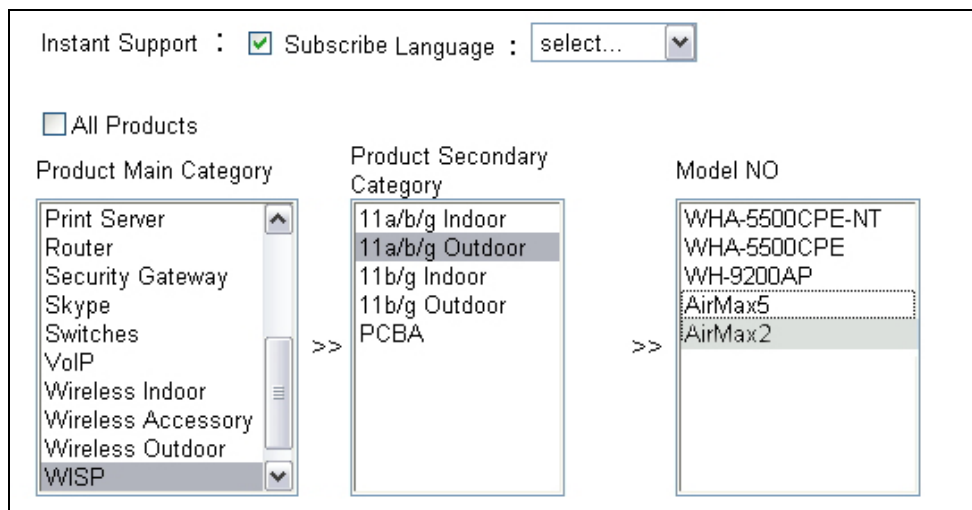

Figure 1.4: AirLive Newsletter Support System

1.3 Features

- 802.11g/b Hi Powered Chipset
- 4MB Flash and 16MB SDRAM
- 9 wireless multi-function modes: Access Point, Client Mode, WDS Repeater, WDS Bridge, Universal Repeater, WISP Router, AP Router, WISP+ Universal Repeater, WDS Station
- 10Bi Integrated Patch Antenna: Vertical Polarization. 70 degree Horizontal and 38 degree Vertical coverage in the forward direction.
- R-SMA connector for external antenna.
- Built from High Temperature resistant ABS material with Anti-UV protection
- Power by passive PoE: 12V Adapter and injector included.
- Slide out housing design for easy maintenance.
- Pole Mount strap included. Optional metal mount and wall mount available
- Interface and IP/MAC Bandwidth Control
- Site Survey, Signal Survey, and Signal Strength LED indicator.
- ClearSignal Interference Resistant Technology
- Emergency firmware recovery mode
- Web, HTTPS, SSH, Telnet managements

1.4 Wireless Operation Modes

The AirMax2 can perform as a multi-function wireless device. Through the AirLogic web interface, users can easily select which wireless mode they wish the AirMax2 to perform.

AirMax2 Wireless Operation Mode			
Wireless Mode	Radio	WAN	Application
Access Point	AP	None	Hotspot (Indoor and Outdoor)
Client	Client	None	WISP Client
WISP Router	Client	Wireless	WISP Client Router
Bridge	Bridge	None	Building to Building network
WDS Repeater	AP + Client	None	Extend distance of another WDS AP/Router

Universal Repeater	AP + Client	None	Extend distance of any AP Router
WISP + Repeater	AP + Client	Wireless	WISP 2-Way CPE (One radio only)
AP Router	AP	LAN Port	Broadband Sharing
WDS Station	Bridge	None	Bridge with SSID

1.4.1 Access Point Mode

When operating in the Access Point mode, the AIRMAX2 becomes the center hub of the wireless network. All wireless cards and clients connect and communicate through AirMax2. This type of network is known as “Infrastructure network”. Other AirMax2 or 802.11a CPE can connect to AP mode through “Client Mode”.



1.4.2 Client Mode

This mode is also known as “Client” mode. For AirMax2, there are 2 types of Client modes: Infrastructure and Adhoc mode. In Infrastructure mode, the AIRMAX2 acts as if it is a wireless adapter to connect with a remote Access Point. Users can attach a computer or a router to the LAN port of AirMax2 to get network access. This mode is often used by WISP on the subscriber’s side.



In Client Ad Hoc mode, AIRMAX2 can connect to other wireless adapters without access point. Users can attach a computer or a router to the LAN port of AirMax2 to get network access.

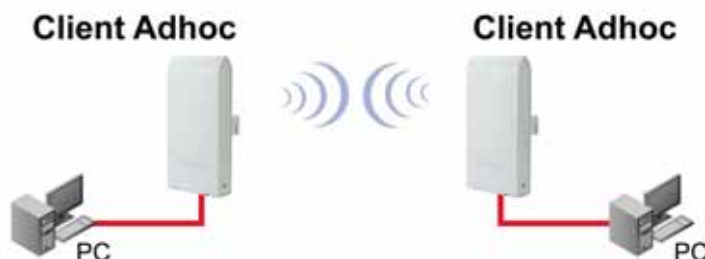

1.4.3 Bridge Mode

This mode is also known as “WDS Pure MAC Bridge mode”. When configured to operate in the Wireless Distribution System (WDS) Mode, the AIRMAX2 provides bridging functions with remote LAN networks in the WDS system. The system will support up to total of 8 bridges in a WDS network (by daisy chain). However, each bridge can only associate with maximum of 4 other bridges in the WDS configuration. This mode is best used when you want to connect LAN networks together wirelessly (for example, between office and warehouse). If you have more than 2 AP in WDS Bridges mode, please remember to turn on the “802.1d Spanning Tree” or “STP” option on to avoid network loop. This mode usually delivers faster performance than infrastructure mode.

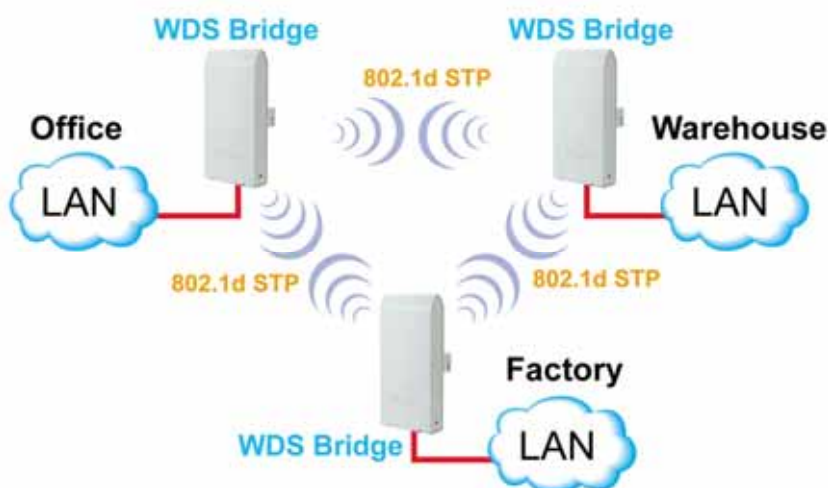

1.4.4 WDS Repeater Mode

In WDS Repeater mode, the AIRMAX2 functions as a repeater that extends the range of remote wireless LAN. In this mode, the remote Access Point must have WDS (Wireless Distribution System) capability. If you require the PC’s MAC addresses to be preserved

when the data pass through the Repeater, it is necessary to use the WDS Repeater mode. Because the radio is divided into WDS + AP mode, the Repeater mode will have less performance and distance. In this mode, it is recommended to use an external Omni-Directional antenna.



1.4.5 Universal Repeater Mode

In Universal Repeater mode, the AIRMAX2 functions as a repeater that extends the range of remote wireless LAN. This mode can repeat the signal of any remote AP/Router, even if they do not have WDS capability. However, the MAC addresses of any wireless traffic going through Universal Repeater are “translated” into the Repeater’s MAC address. As a result, any applications that require identification by MAC address (such as hotspot or firewall) can not use this mode. It is also recommended to use “DHCP” Relay function to get IP address from remote DHCP server.

Because the radio is divided into WDS + AP mode, the Repeater mode will have less performance and distance. In this mode, it is recommended to use an external Omni-Directional antenna.



1.4.6 WISP Router Mode

In WISP Router Mode, AIRMAX2 connects to the remote Access Point as in Client Infrastructure Mode. On the LAN side, it acts like a wired router for IP sharing function. This mode is best used for IP sharing application for WISP subscribers. In this mode, the WAN is the wireless client side, the LAN is the wired side.

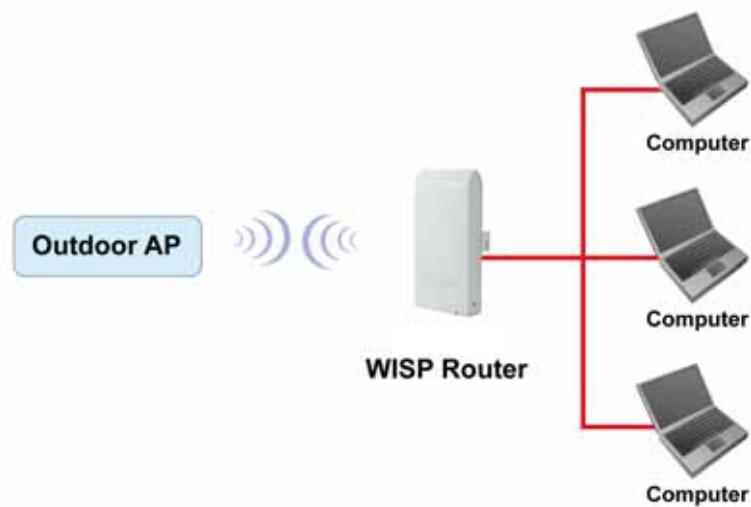

1.4.7 WISP + Repeater Mode

This mode is the combination of WISP Router mode and AP mode. The radio is divided into 2-way. One way is the client mode to connect with the remote AP, the other is the AP mode to serve the local wireless network. There is a NAT router function to share the Internet connection. Since the radio is divided by half, it is not recommended for long distance application. The use of external Omni-Directional Antenna .

If you are a WISP operator, it is highly recommended that you use a 2-radio product like AirLive G.DUO(dual 11g AP) or WLA-9000AP(A+G AP) for this purpose.



1.4.8 AP Router Mode

In AP Router Mode, the AirMax2 behaves like a wireless router. The LAN port of the AirMax2 will become WAN port. The wireless network of AirMax2 becomes the LAN side. Please note when this mode is used, the only way to manage the AirMax2 is through the wireless side unless remote management is opened.



1.4.9 WDS Station(Bridge Send Beacon)

The WDS Station mode is similar to Bridge mode with the exception that the link has added "SSID" as basis for the bridge link. This mode is for added bridge mode compatibility with Atheros base wireless device.

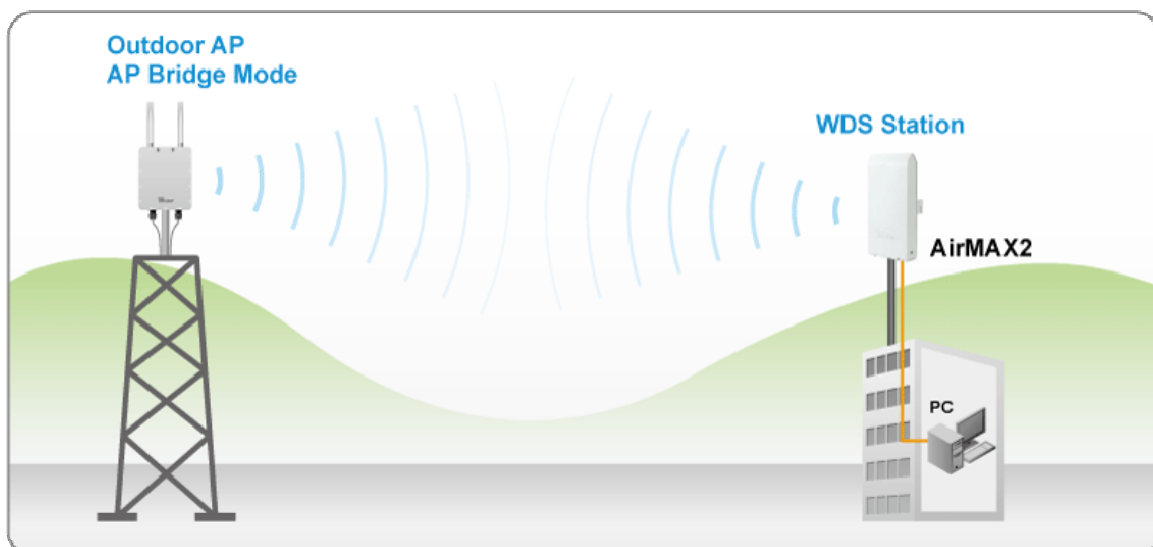

2

Installing the AirMax2

This section describes the hardware features and the hardware installation procedure for the AIRMAX2. For software configuration, please go to chapter 3 for more details.

2.1 Before You Start

It is important to read through this section before you install the AirMax2

- The AirMax2 comes with everything you need to start installation with exception of the PoE Ethernet Cable. You can use a good quality CAT-5E outdoor graded Ethernet cable (shielded with anti-UV) according to the length you need.
- The AirMax2 must be installed in the upright position if the unit is located in outdoor or wet environments.

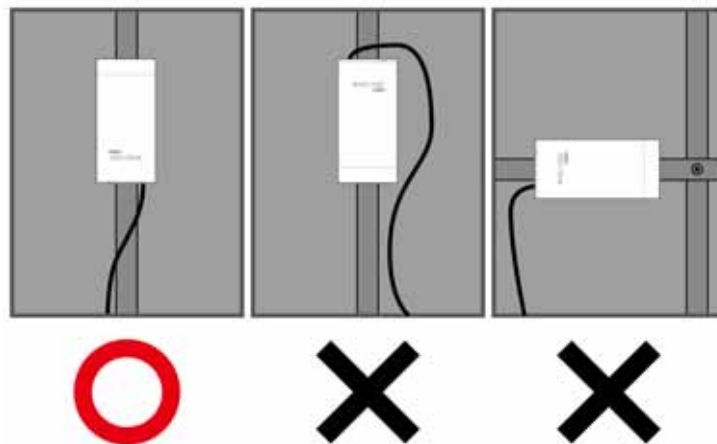

- The integrated antenna has forward coverage angle of 70 degree horizontal and 38 degree vertical.

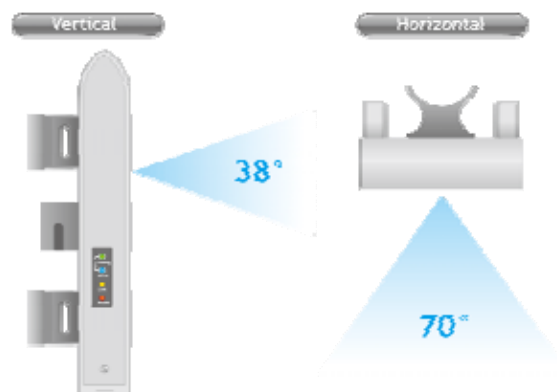

- If you choose to use the external antenna, please remember to connect the external antenna first before power on AirMax2.
- If you choose to use the external antenna, please make sure to change the software settings to use the “external” antenna.

2.2 Package Content

The AIRMAX2 package contains the following items:

- One AirMax2 main unit
- One 12V 1A DC power adapter
- Passive PoE DC Injector
- 2 x Plastic Straps
- User’s Guide CD
- Quick Start Guide



The PoE Ethernet cable is not included in the package. You may choose an outdoor specification Ethernet cable according to the length you need.

2.3 Optional Accessories

The AirMax2 have the following optional accessories which you can purchase from AirLive

- Tilting Metal Wall/Pole Mount (*Model: WMK-AIRMAX*): This kit allows your AirMax2 to tilt in pole mount, it also allow you to install the AirMax2 to the wall.
- 25 meter PoE cable (*Model: OD-25M*): high quality outdoor graded anti-UI PoE Ethernet Cable.



2.4 Knowing Your AirMax2

Below are descriptions and diagrams of the product:

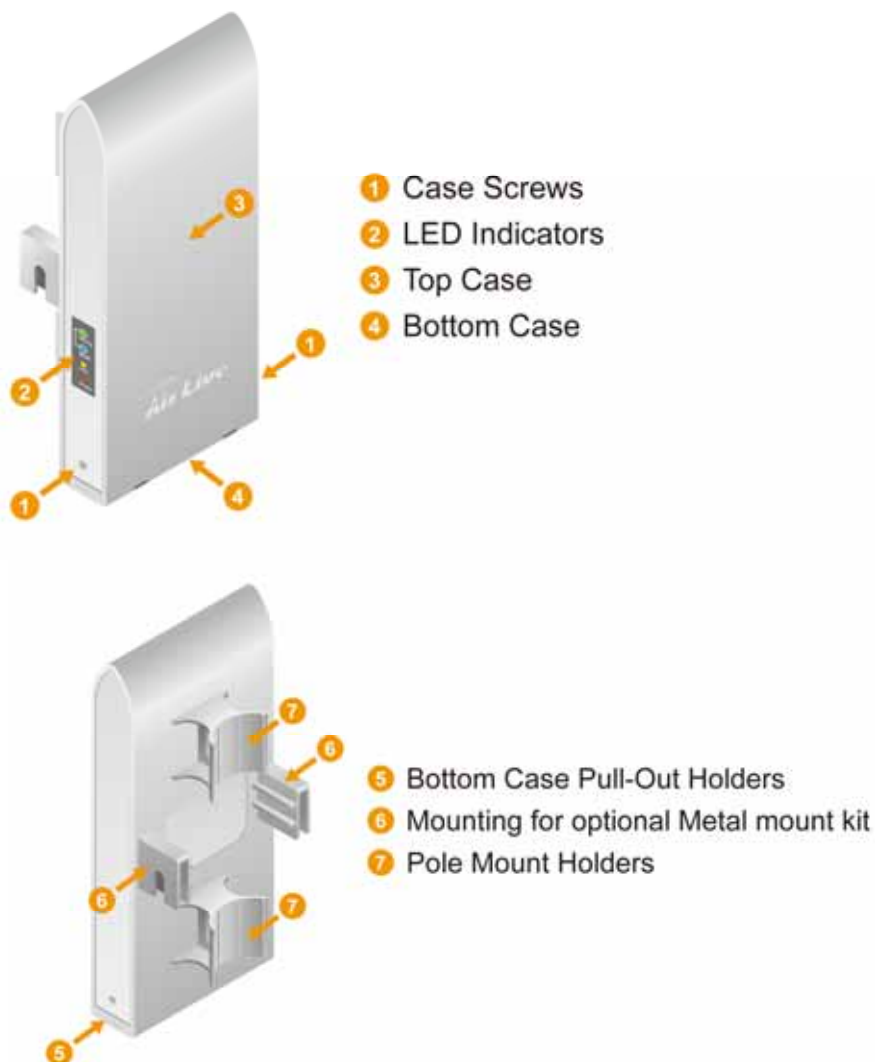

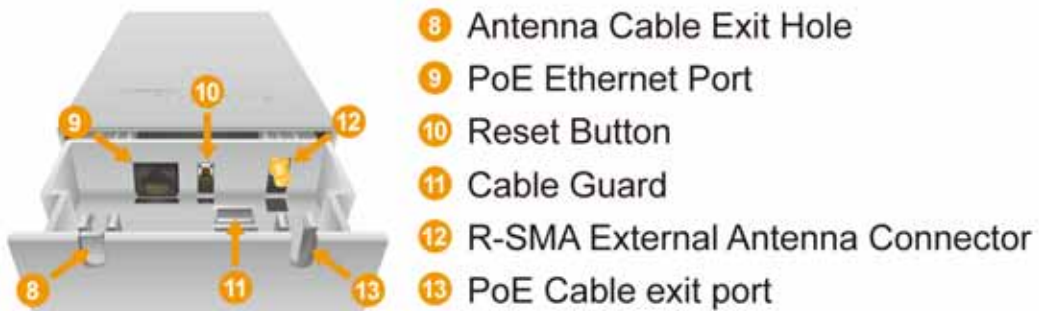

2.5 Hardware Installation

Please prepare a screw driver and an outdoor graded PoE Ethernet cable with adequate length according to your need.

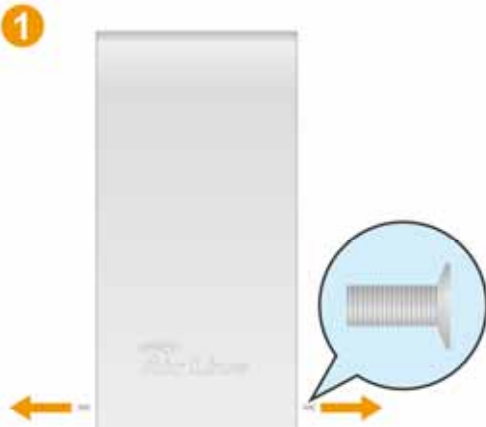
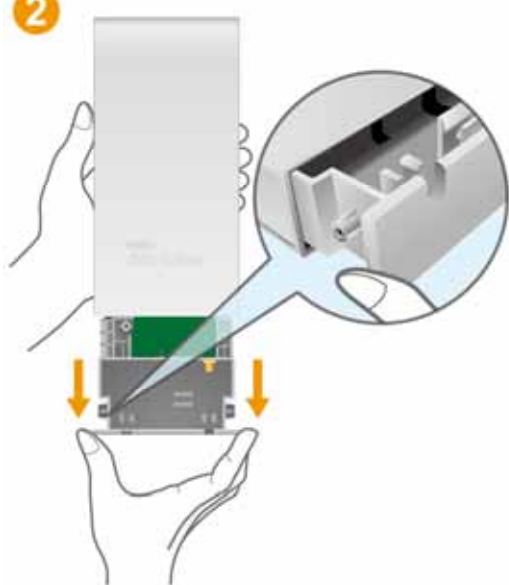
<p>1. Remove the screws from the sides of the case.</p>	<p>2. Hold the sides of the bottom cases and pull out in the downward direction.</p>
	
<p>3. Install the PoE cable to the PoE Port. Follow the cable guard direction.</p>	<p>4. Slide back the bottom case</p>

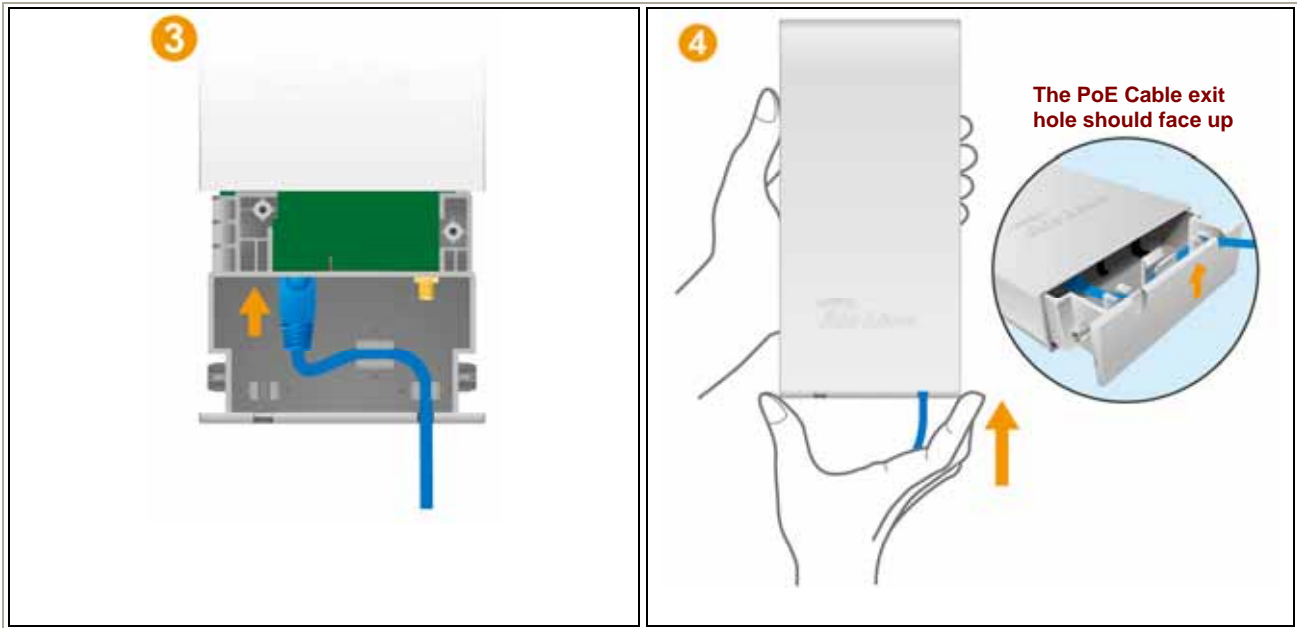

5. Put the case screws back.

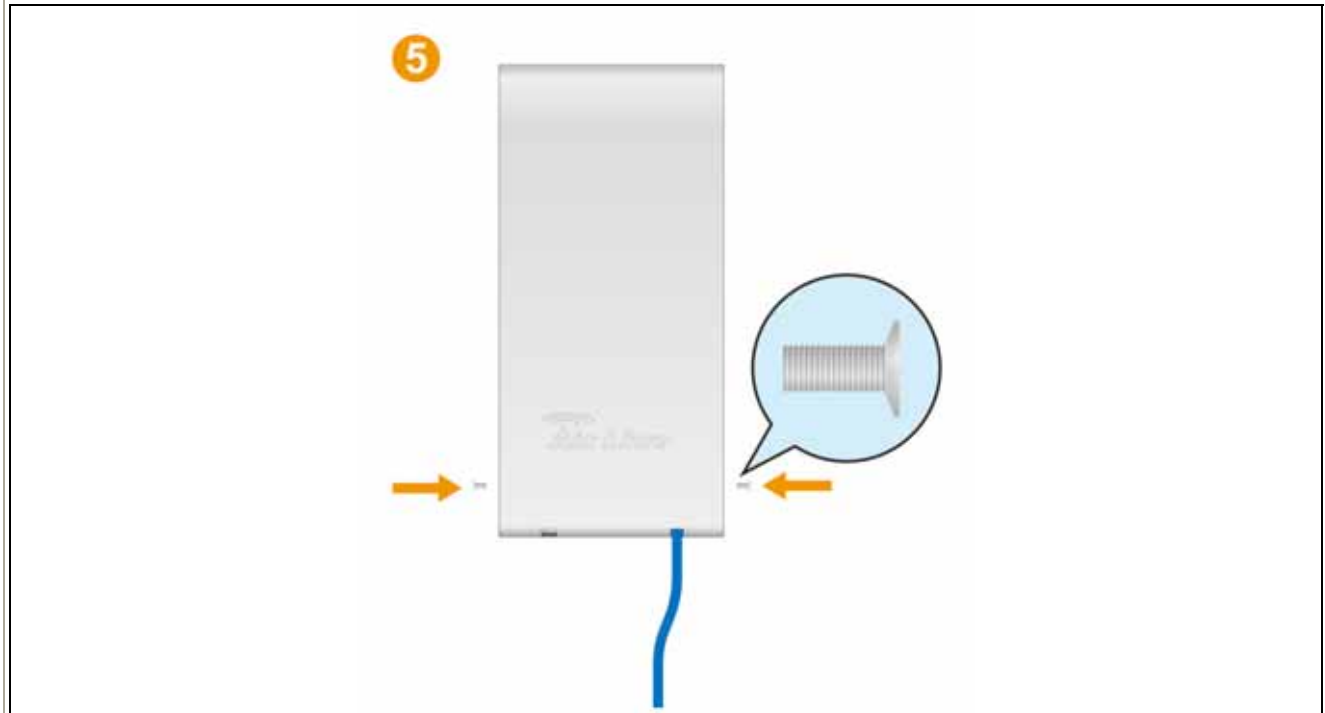

6. Install the PoE Cable and the Power Adapter to the DC Injector. Please make sure to read the markings on the DC Injector carefully and connect the cables correctly. You can connect your PC directly to the "LAN" port of the DC Injector.

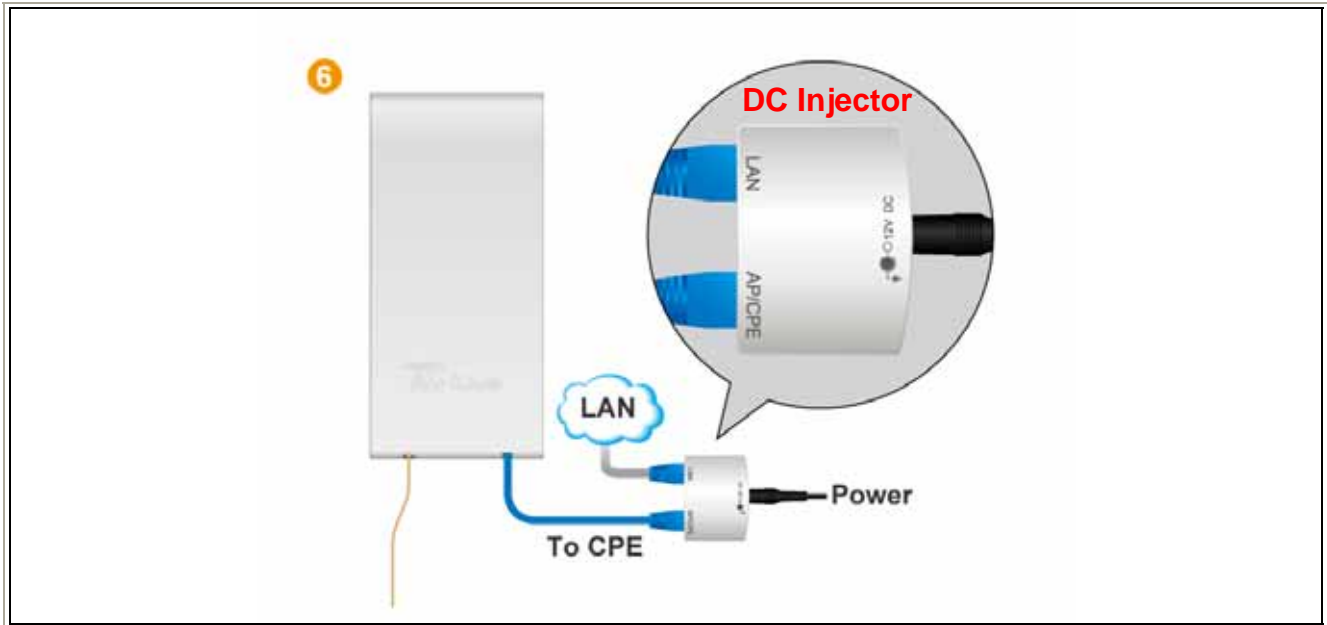

2.5.1 Standard Pole Mount

Your AirMax2 comes standard with 2 plastic straps for pole mounting. Please follow the procedure below to install:

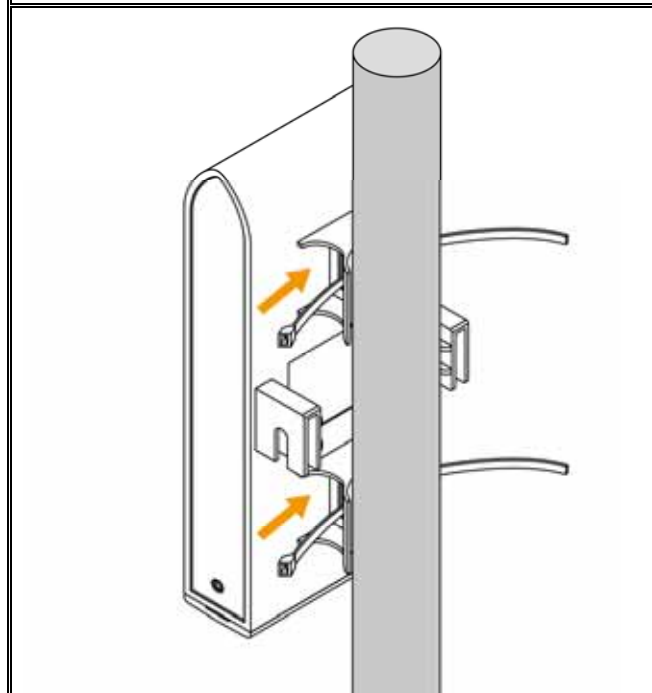
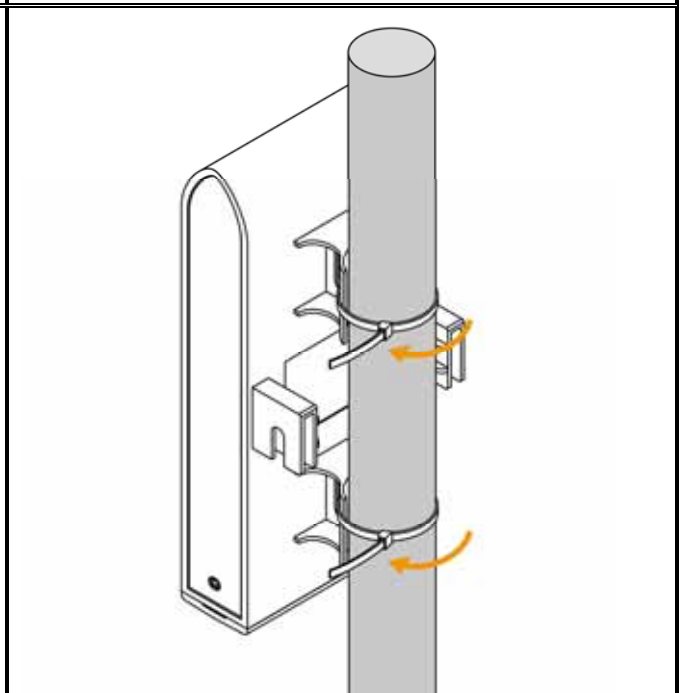
<p>1. Put the plastic strap through the holes on the Pole Mount holders.</p>	<p>2. Thread the thinner end of the strap into the opening on the other pole end. Then tighten the strap around the pole as tightly as possible.</p>
	

2.5.2 Optional Tilting Metal Pole/ Wall Mount

The optional **WMK-AIRMAX** metal pole/wall mount kit allows your AirMax2 to be mounted on the wall and pole. It enables you to tilt the AirMax2 to the desired vertical angle. If you have purchased such kit, please follow the instruction below to mount your AirMax

Wall Mount Installation using WMK-AIRMAX

1. Please first install the screw anchors into the wall
2. Secure the screws through the Metal Bracket into the screw anchors

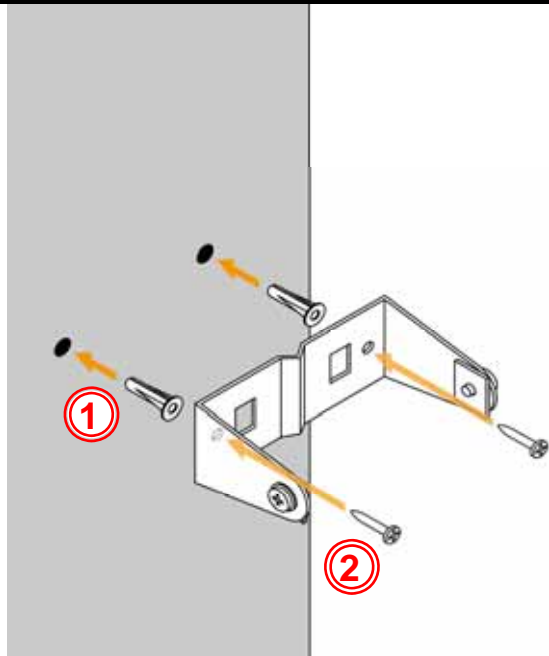

3. Install the AirMax2 into the Metal Bracket and tighten the screws on the bracket.

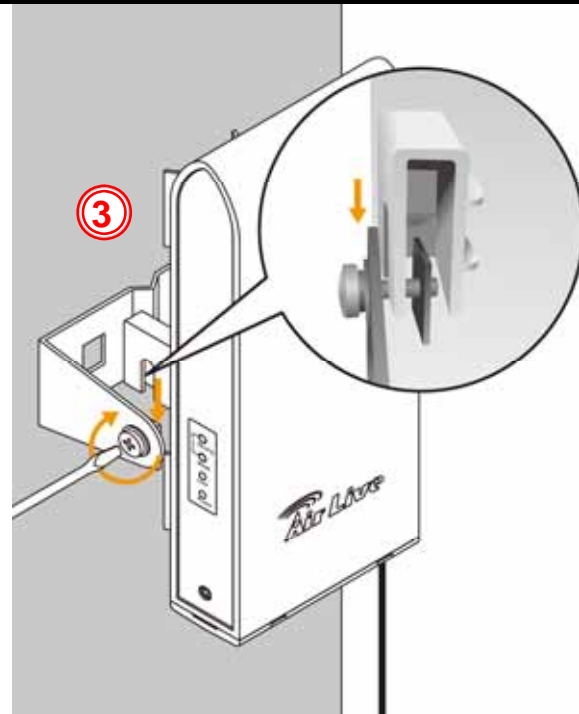

4. By adjusting the bracket screws, you can adjust the tilting angle of the AirMax2

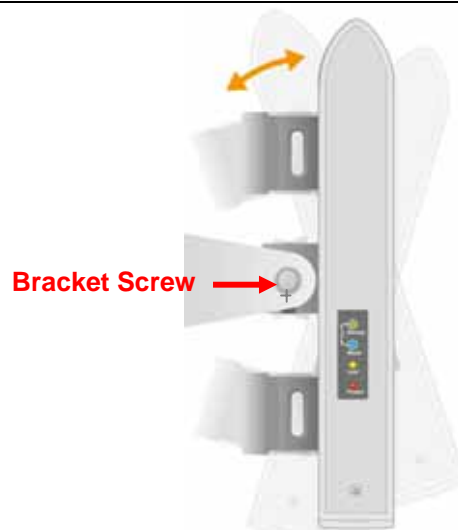

Pole Mount Installation using WMK-AIRMAX

1. Unscrew the metal ring(pipe fastener) until one end of the ring come off completely
2. Put the metal ring through the holes on the bracket and wrap it around the pole.
3. Tighten the screw on the ring until the ring is very tight around the pole.

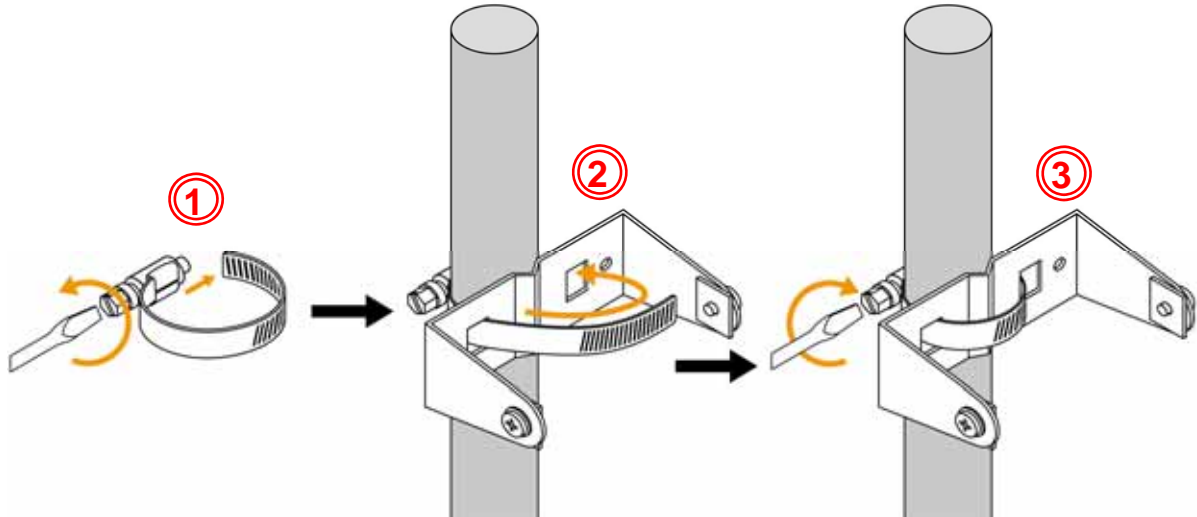

4. Now, install the AirMax 5 into the metal bracket and tighten the screws on the bracket
5. By adjusting the bracket screws, you can adjust the tilting angle of the AirMax2

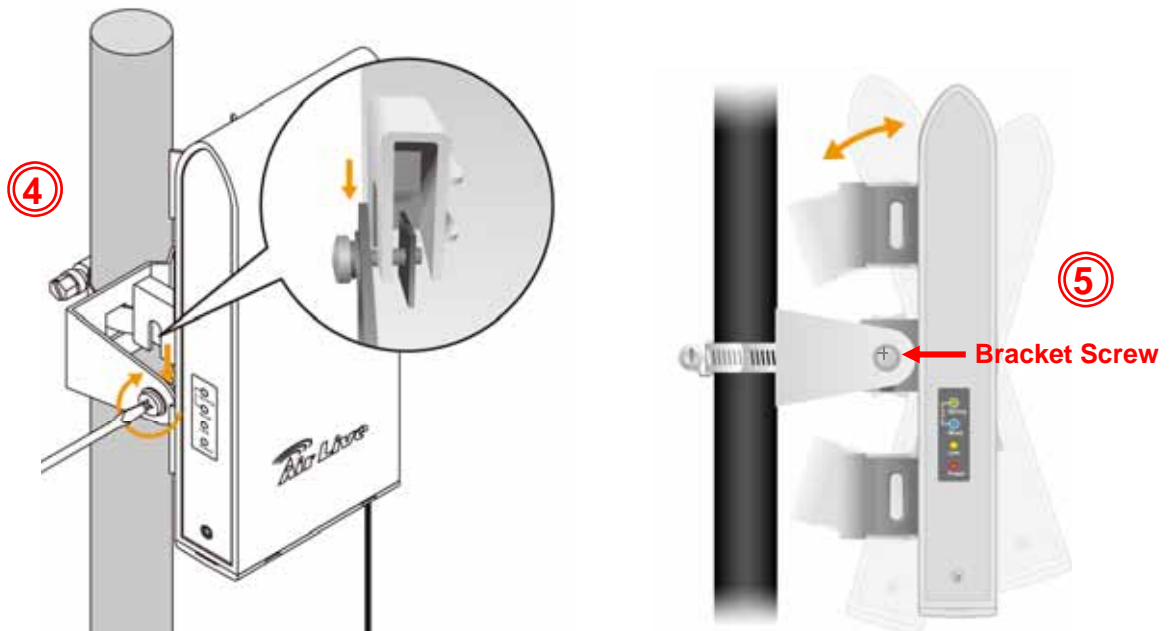





2.5.3 Installing External Antenna

The AirMax is equipped with a 10dBi built-in patch antenna. If the built-in antenna can not meet your requirement, you can connect AirMax2 with an external antenna via the female R-SMA antenna connector.

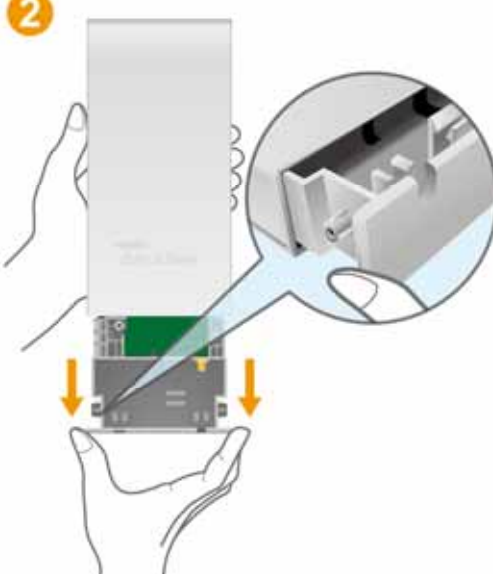
Before you start, you would need an antenna converter cable. For example; if you want to connect directly to an outdoor antenna with female N-Type connector, you would need a Male R-SMA to Male N-Type connector. Please note that you should not connect the power until the external antenna is attached to avoid damaging the RF.

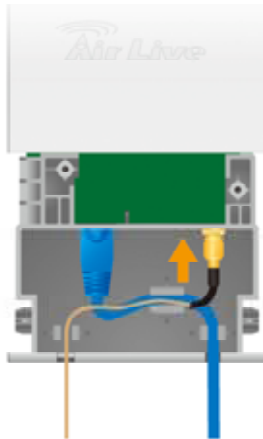
Once you have the converter cable, please follow the installation steps below.

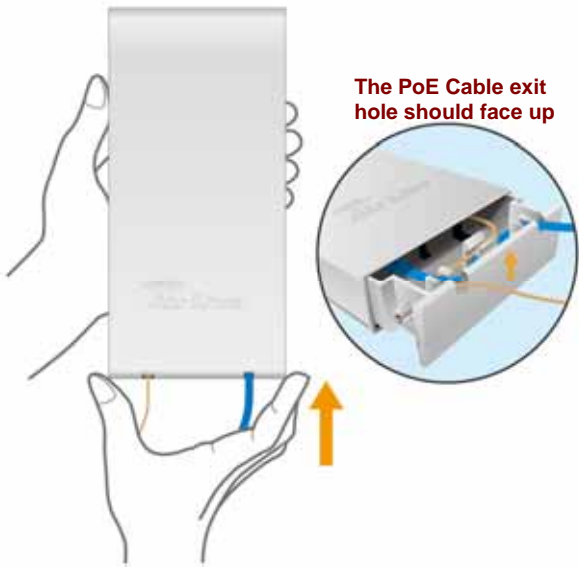
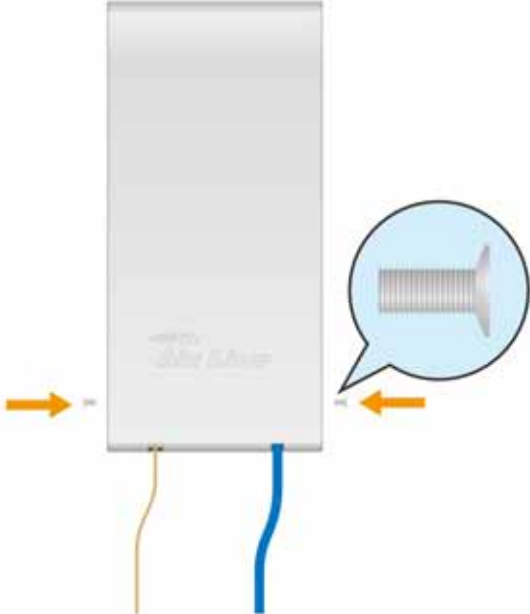
<p>1. Remove the screws from the side of the case.</p>	<p>2. Hold the sides of the bottom case and pull out in the downward direction.</p>
	
<p>3. Use a prier to remove the stab that covers the antenna cable exit hole.</p>	<p>4. You can now connect the converter cable to the antenna port. Please run the cable through the cable guard as indicated below.</p>
	
<p>5. Push back the bottom case.</p>	<p>6. Insert the case screws back</p>

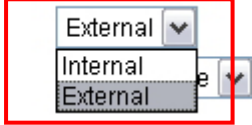
 <p>The PoE Cable exit hole should face up</p>	
<p>7. You should connect the AirMax2 to an external antenna before power on to avoid damaging the RF</p>	<p>8. Please go to the web configuration. Select "Wireless Settings -> Antenna Select". Change the "Antenna Setting" to "External".</p>
	<p>Antenna Select: <input type="text" value="External"/></p> <p>Network Type: <input type="text" value="External"/></p> 

2.6 LED Table

This section describes the LED behavior of AirMax2.

You can find the LED on the left side of the AirMax2.

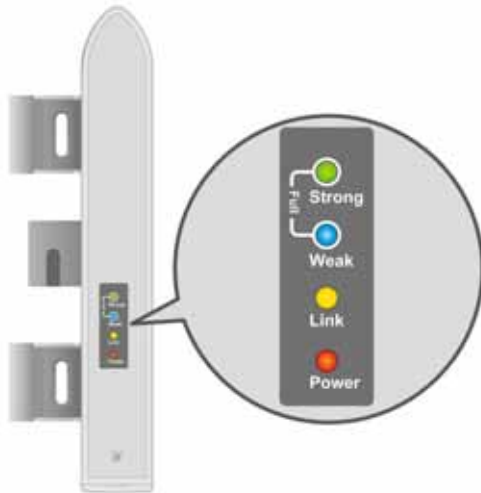

Power

- Steady Red – Normal Operation
- OFF – No Power

Link

- Steady Yellow: Link is active
- Flashing Yellow: Transmit or receive data
- OFF: No connection

WLAN Signal Strength LEDs

- Weak :Low signal strength
- Strong :Better signal strength
- Weak + Strong: Full Signal strength
- ● No connection/Bad signal strength

2.7 Restore Settings to Default

If you have forgotten your AirMax2's IP address or password, you can restore your AirMax2 to the default settings by pressing on the "reset button" for more than 5 seconds. The reset button is inside the bottom case. Please see diagram below for details.



3

Configuring the AirMax2

The AirMax2 offers many different types of management interface. You can configure through standard web browser (http), secured web (https), command line (telnet), and secured command shell (SSH). In this chapter, we will explain AirMax2's available management interfaces and how to get into them.

3.1 Important Information

The following information will help you to get start quickly. However, we recommend you to read through the entire manual before you start. Please note the password and SSID are case sensitive.

- The default IP address is: 192.168.1.1 Subnet Mask: 255.255.255.0
- The default user's name is: admin
- The default password is: airlive
- The default SSID is: airlive
- The default wireless mode is : Client mode
- After power on, please wait for 2 minutes for AirMax2 to finish boot up
- Please remember to click on "Apply" for new settings to take effect
- You must reboot the AirMax2 after you finish all the settings for changes to take effect**
- The ClearSignal Technology is "OFF" by default. If there are heavy interference around your environment. Please turn it on.
- When you change to "AP Router" mode, the LAN port will become WAN port. The IP address is changed to "192.168.2.1".

3.2 Prepare your PC

The AIRMAX2 can be managed remotely by a PC through either the wired or wireless network. The default IP address of the AIRMAX2 is **192.168.1.1** with a *subnet mask* of 255.255.255.0. This means the IP address of the PC should be in the range of 192.168.1.2 to 192.168.1.254.

To prepare your PC for management with the AirMax2, please do the following:

1. Connect your PC directly to the LAN port on the DC Injector of AirMax2

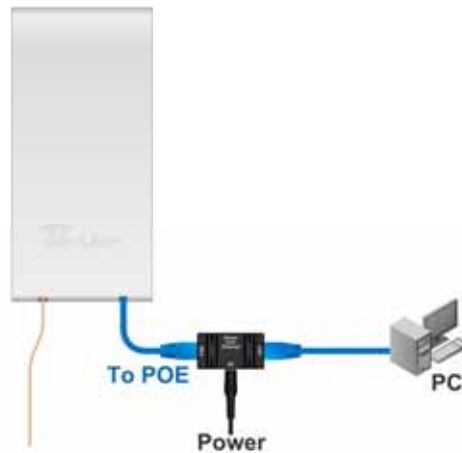

2. Set your PC's IP address manually to 192.168.1.100 (or other address in the same subnet)

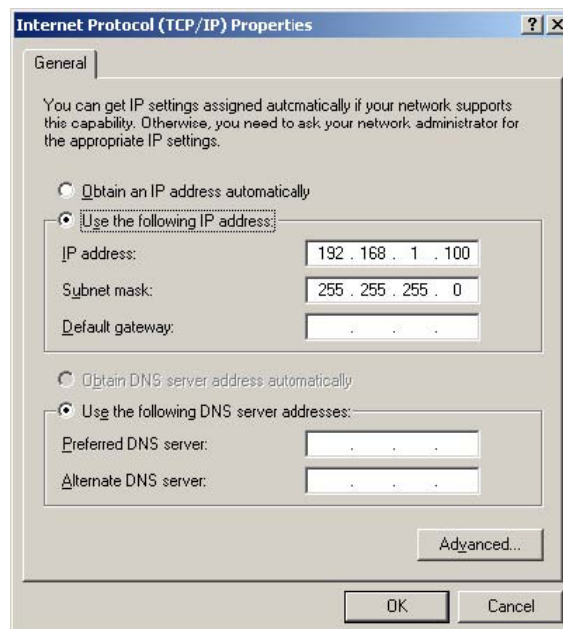

You are ready now to configure the AirMax2 using your PC.

3.3 Management Interface

The AirMax can be configured using one the management interfaces below:

- **Web Management (HTTP):** You can manage your AirMax2 by simply typing its IP address in the web browser. Most functions of AirMax2 can be accessed by web management interface. We recommend using this interface for initial configurations. To begin, simply enter AirMax2's IP address (default is 192.168.1.1) on the web browser. The default username is "admin" and password is "airlive".

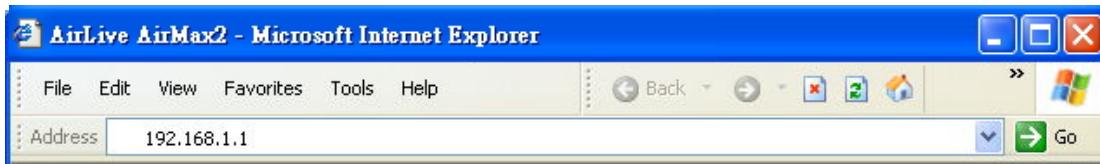

- **Secured Web Management (HTTPS):** HTTPS is also using web browser for configuration. But all the data transactions are securely encrypted using SSL encryption. Therefore, it is a safe and easy way to manage your AirMax2. We highly recommend WISP and service provider to use HTTPS for management.

To begin, simply enter <https://192.168.1.1> on your web browser. A security alert screen from your browser will pop up. Please grant all permission and get certificate to AirMax2. After you pass the security warning screen, you will enter the secured web management interface. The default username is "admin" and password is "airlive".

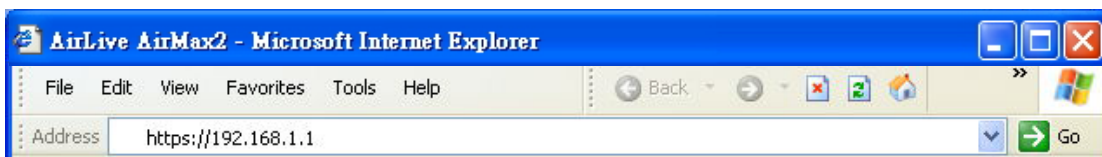

- **Command Line Interface (Telnet):** AirMax2 can be managed through the command line interface (CLI). It is possible to write a text script file, and then paste it into the CLI to execute several commands at once. However, Telnet does not encrypt its message. Therefore, it is not secure. The default Telnet management port is TCP port 23.

To use the CLI, please open the command line window. Then type "telnet 192.168.1.1" to start.

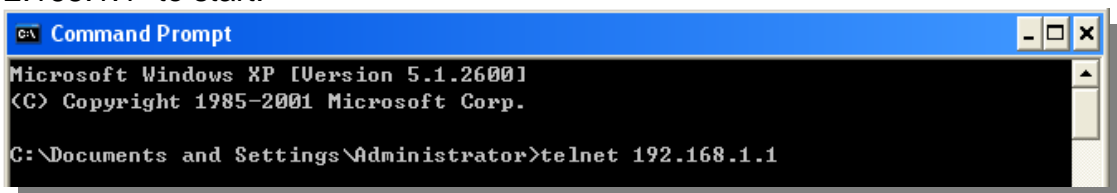

When asked for password, please enter "airlive".

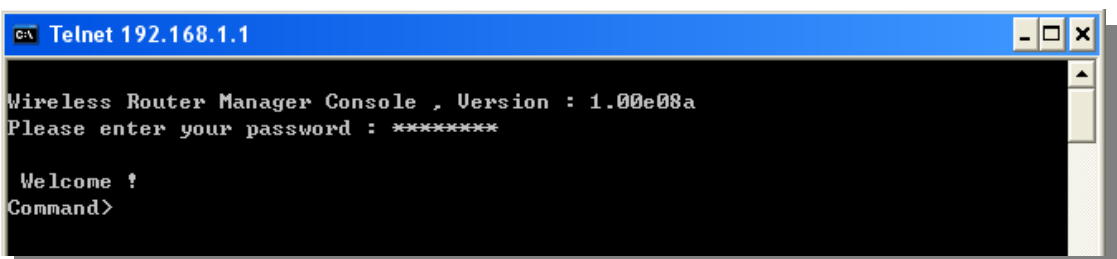

- **Secure Shell (SSH, SSH2):** SSH is an encrypted Command Line Interface that allow user to send text commands through SSL encryption. Therefore, it provides the added advantage of security comparing to Telnet. As with Telnet, the SSH and SSH2 provide the possibility to write a text script and paste into the CLI interface for multiple command execution. It also makes configuration change across many AirMax2s easier. The default management port for SSH/SSH2 is TCP/UDP port 22.

To manage via the SSH/SSH2 protocol, you would need a SSH client. Free SSH clients are widely available on the Internet. You can find where to download them by using Internet search engine such as Google. In this guide, we will use a popular SSH/Telnet utility called “Putty”.

Once you have download and install Putty. Please follow the figure below to make a connection with AirMax2:

1. Choose “SSH” as indicated in the diagram
2. Enter the IP address of AirMax2
3. Click on “Open” to start the SSH session.

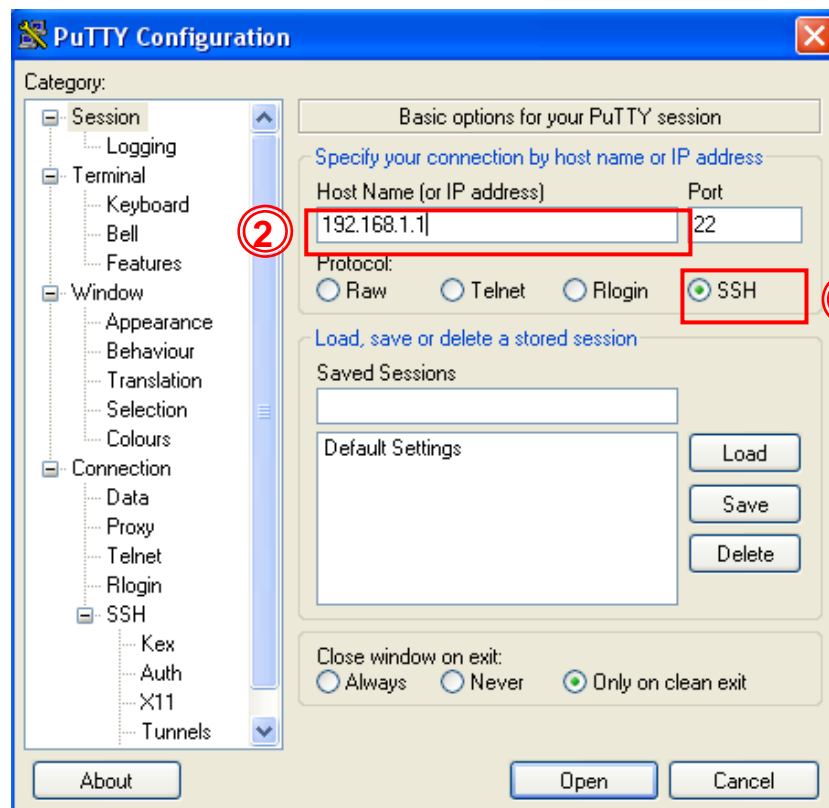

When the following screen appear, click on “Yes” to continue



When asked for username, please enter “admin”. When asked for password, please enter “airlive” as factory default. This password will change when you change the password.



3.4 Introduction to Web Management

The AirMax2 offers both normal (http) and secured (https) Web Management interfaces. They share the same interface and functions, and they can both be accessed through web browsers. The only difference is HTTPS are encrypted for extra security. Therefore, we will discuss them together as “Web Management” on this guide.

If you are placing the AirMax2 behind router or firewall, you might need to open virtual server ports to AirMax2 on your firewall/router

- HTTP: TCP Port 80
- HTTPS: TCP/UDP Port 443

This procedure is not necessary in most cases unless there is a router/firewall between your PC and AirMax2.

3.4.1 Main Menu

After key in the correct username and password, you will enter the main Web management screen.

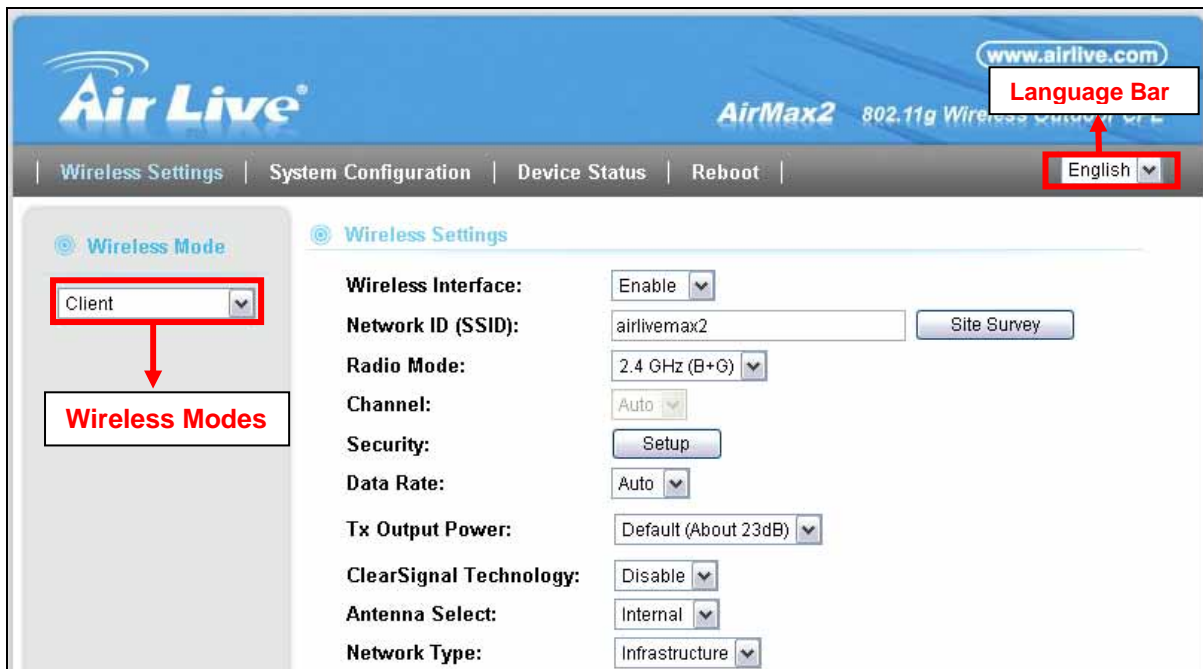

- **Wireless Settings:** You will find all the settings for wireless and WAN settings in this page. The AirMax2's wireless settings are different between wireless modes. Only functions that are applicable to the wireless mode will show to simplify configuration. For example, WAN Port is only displayed in WISP Router and AP Router modes.
- **Wireless Mode:** On the left hand side bar, you will find the "Wireless Mode" pull down menu. The menu will display what is the current wireless mode. You can change mode by the pull down menu. The AP will ask you to confirm for the mode change and reboot to the new wireless mode.
- **System Configuration:** All non-wireless and router mode settings are in this category. The system configurations including changing password, upload firmware, backup configuration, settings PING watchdog, and setting management interface.
- **Device Status:** This section for monitoring the status of AirMax2. It provides information on device status, Ethernet status, wireless status, wireless client table, and system log.
- **Reboot:** Please remember to save changes and reboot after you finish all settings. The changes will take effect only after reboot.
- **Language Bar:** You can select different language for the web management interface here.

3.5 Initial Configurations

We recommend users to browse through AirMax2’s web management interface to get an overall picture of the functions and interface. Below are the recommended initial configurations for first time login:

3.5.1 Changing the Regulatory Domain

The Regulatory Domain decides what channels and Tx output power levels are available for your country. In most cases, the Regulatory Domain is already selected correctly for your country. Please note that using the wrong Regulatory Domain is strictly prohibited. If you live inside EU, you must use the ETSI Regulatory Domain. If you live in United States, you must use FCC domain.

The AirMax2 is available with the following Regulatory Domain:

Regulatory Domain	Available Channels	Maximum Tx Output Power
ETSI (Europe)	1 ~13	20dBm
FCC (United States)	1~11	23dBm
South America(11 CH)	1~11	26dBm
South America(14 CH)	1~14	26dBm

To change Regulatory Domain, please go to the “Wireless Settings” page.



3.5.2 Change the Device’s IP Address

The default IP address is at 192.168.1.1. You should change it to the same subnet as your network. Also, if you want to manage AirMax2 remotely, you have to set the Gateway and DNS server information.

To setup the IP settings for AirMax2, please select “System Configuration” -> Device IP Settings”. After entering the IP information, click on “Apply Changes” to finish.



3.5.3 Set the Time and Date

It is important that you set the date and time for your AirMax2 so that the system log will record the correct date and time information. Please go to “System Configuration” -> Time Settings. We recommend you choose “Enable NTP” so the time will be keep even after reboot. If your AirMax2 is not connected to Internet, please enter the time manually. Please remember to select your local time zone and click “Apply” to finish.

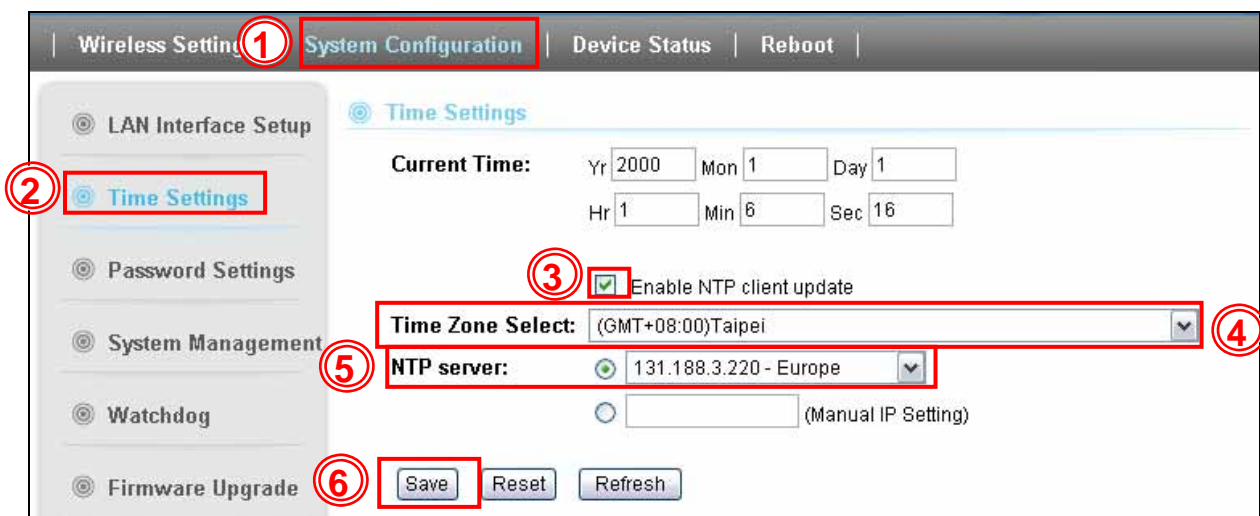

3.5.4 Enable/Disable Telnet and SSH Management

The Telnet and SSH management interface are turned off by default. If you wish to use them, please go to the “System Configuration -> System Management” menu. Check “Telnet” or “SSH”, then click on “Apply Change” button.

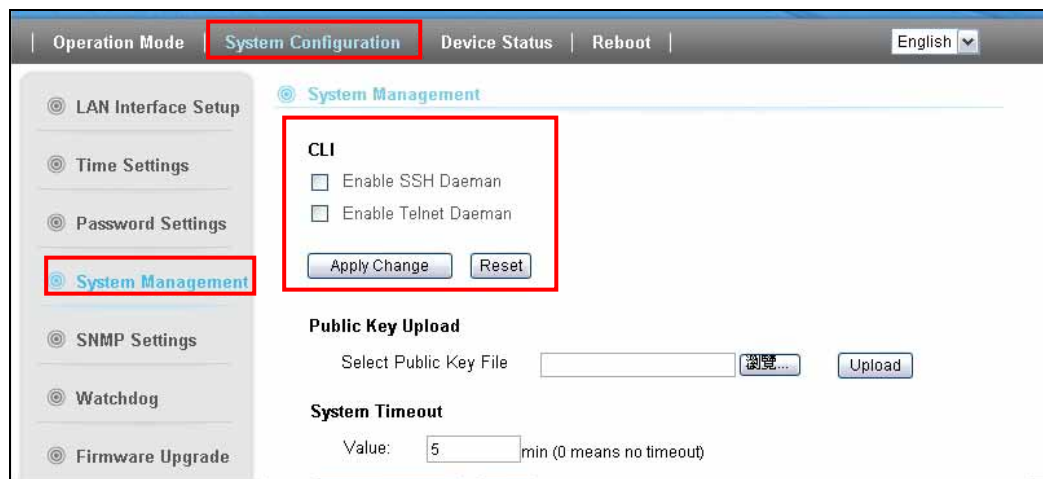

3.5.5 Change Password

You should change the password for AirMax2 at the first login. To change password, please go to “System Configuration” -> “Password Settings” menu.

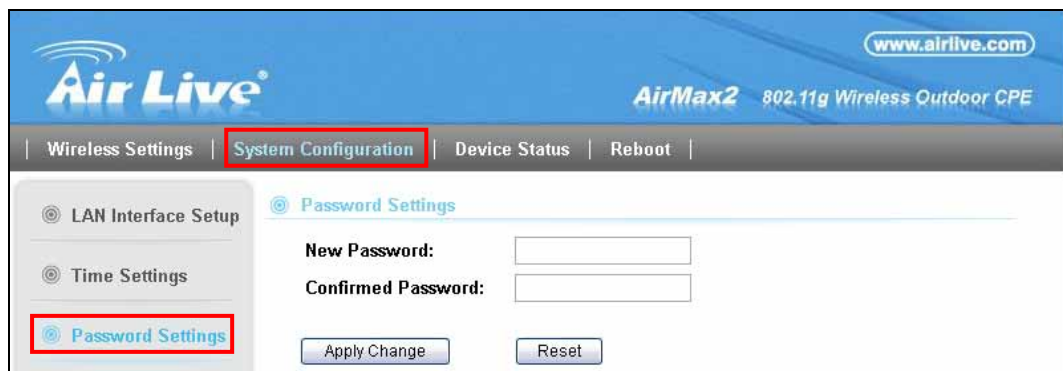

4

Wireless Settings

In this chapter, we will explain about the wireless settings in web management interface. Please be sure to read through Chapter 1's Wireless Operation Mode and Chapter 3's "Introduction to Web Management" and "Initial Configurations" first.

Although router mode settings (WAN port, Virtual Server...etc) are part of the wireless settings menu, they will be explained in Chapter 5.

4.1 About Wireless Modes

The AirMax2 has total of 9 operation modes to suit different application requirements. In this section, we will explain how to change between wireless operation modes. For explanation on each different operation mode, please read Chapter 1 section 1.4 first.

Below is the summary table for different wireless modes:

AirMax2 Wireless Operation Mode			
Wireless Mode	Radio	WAN	Application
Access Point	AP	None	Hotspot (Indoor and Outdoor)
Client	Client	None	WISP Client
WISP Router	Client	Wireless	WISP Client Router
Bridge	Bridge	None	Building to Building network
WDS Repeater	AP + Client	None	Extend distance of another WDS AP/Router
Universal Repeater	AP + Client	None	Extend distance of any AP Router
WISP + Repeater	AP + Client	Wireless	WISP 2-Way CPE (One radio only)
AP Router	AP	LAN Port	Broadband Sharing
WDS Station	Bridge	None	Bridge with SSID

To change between different wireless mode, please to go the "Wireless Settings" menu, on the left hand side bar, you will see the "Wireless Mode" pull down menu which displays the current operation mode.

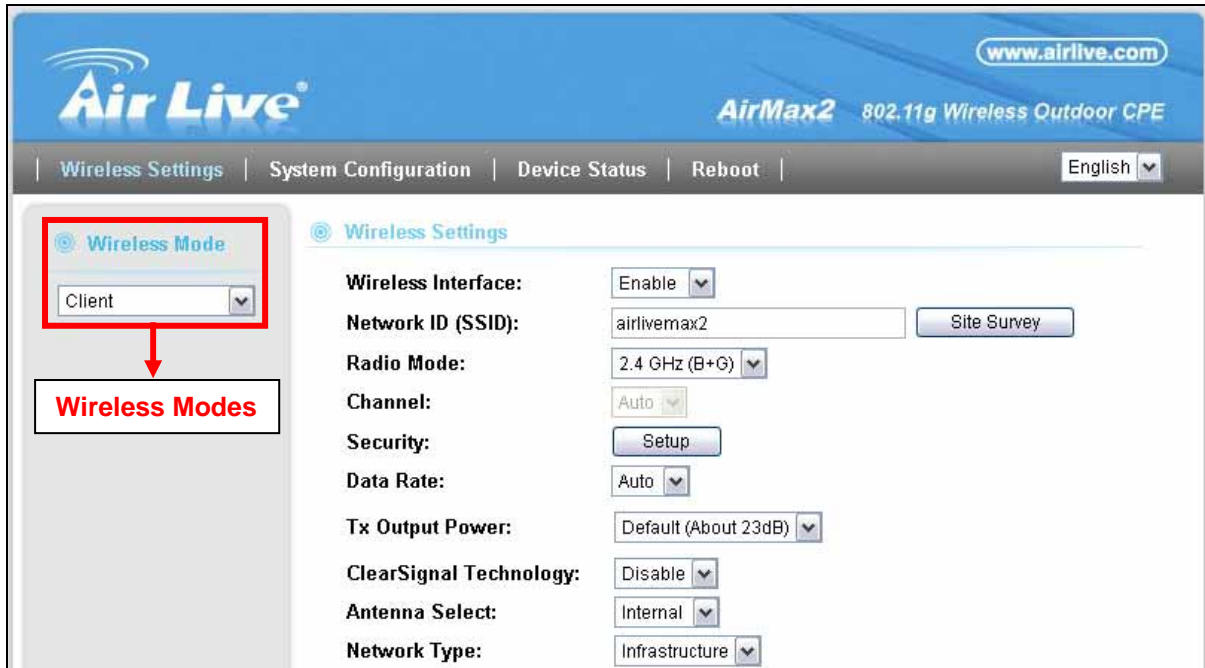

To change wireless mode, please select the new wireless mode from the pulldown menu. The AirMax2 will ask you to confirm about the mode change. After your confirmation, the AP will reboot itself to the new mode.



The AirMax2 only have one LAN port. After you change to the "AP Router" mode, the LAN port will become WAN port. And the IP address will be changed to 192.168.2.1.

4.2 General Wireless Functions

This section will explain the general wireless functions. Not all functions are available in every wireless mode. Please refer to the web interface what is available of each mode.

When you select “*Wireless Settings*” on the top menu; the following screen will appear:

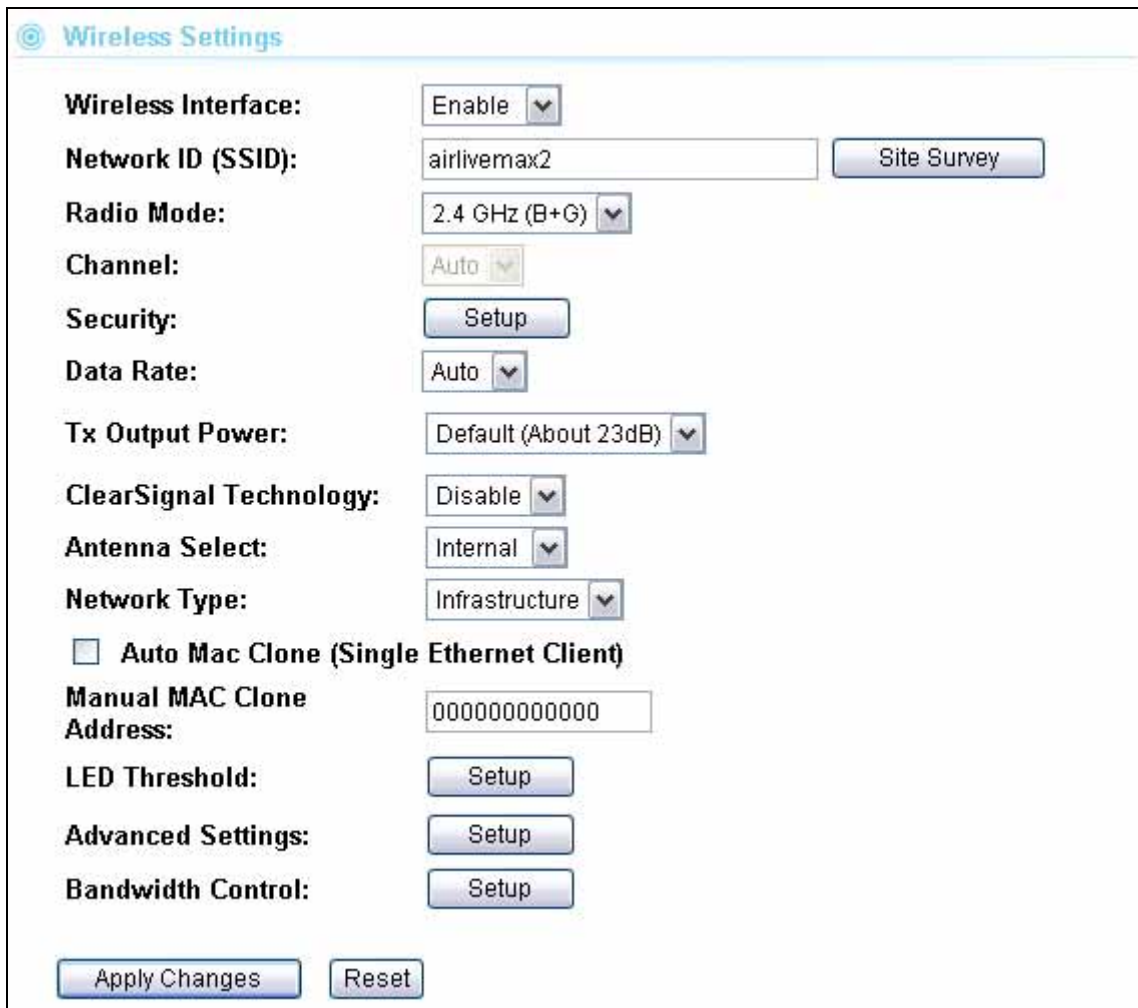

The screenshot shows the 'Wireless Settings' configuration page. It includes the following fields and controls:

- Wireless Interface:** Enable (dropdown)
- Network ID (SSID):** airlivemax2 (text input) with a **Site Survey** button
- Radio Mode:** 2.4 GHz (B+G) (dropdown)
- Channel:** Auto (dropdown)
- Security:** Setup (button)
- Data Rate:** Auto (dropdown)
- Tx Output Power:** Default (About 23dB) (dropdown)
- ClearSignal Technology:** Disable (dropdown)
- Antenna Select:** Internal (dropdown)
- Network Type:** Infrastructure (dropdown)
- Auto Mac Clone (Single Ethernet Client)**
- Manual MAC Clone Address:** 000000000000 (text input)
- LED Threshold:** Setup (button)
- Advanced Settings:** Setup (button)
- Bandwidth Control:** Setup (button)

At the bottom, there are **Apply Changes** and **Reset** buttons.

4.2.1 Regulatory Domain

Wireless Settings -> Regulatory Domain

The Regulatory Domain decides what channels and Tx output power levels are available for your country. In most cases, the Regulatory Domain is already selected correctly for your country. Please note that using the wrong Regulatory Domain is strictly prohibited. If you live inside EU, you must use the ETSI Regulatory Domain. If you live in United States, you must use FCC domain.

The AirMax2 is available with the following Regulatory Domain:

Regulatory Domain	Available Channels	Maximum Tx Output Power
ETSI (Europe)	1 ~13	20dBm
FCC (United States)	1~11	23dBm
South America(11 CH)	1~11	26dBm
South America(14 CH)	1~14	26dBm

4.2.2 Network SSID

Wireless Settings -> Network SSID

The SSID is the network name used to identify a wireless network. The SSID must be the same for all devices in the same wireless network. The SSID length is up to 32 characters. The default SSID is “airlive”.

4.2.3 Site Survey

Wireless Settings -> Site Survey

You can scan for wireless networks around your location using the Site Survey function. From the site survey function, you can also perform antenna alignment and establish wireless connection

When you click on Site Survey, the following screen will appear. It might take awhile depending on number of available APs in the area.

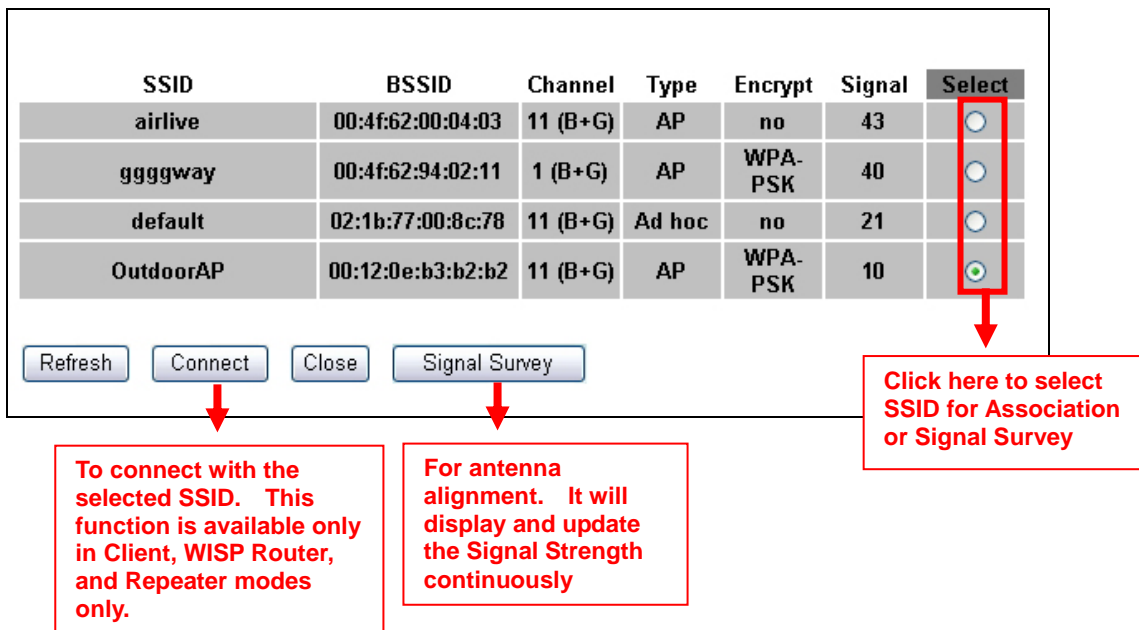

SSID	BSSID	Channel	Type	Encrypt	Signal	Select
airlive	00:4f:62:00:04:03	11 (B+G)	AP	no	43	<input type="radio"/>
ggggway	00:4f:62:94:02:11	1 (B+G)	AP	WPA-PSK	40	<input type="radio"/>
default	02:1b:77:00:8c:78	11 (B+G)	Ad hoc	no	21	<input type="radio"/>
OutdoorAP	00:12:0e:b3:b2:b2	11 (B+G)	AP	WPA-PSK	10	<input checked="" type="radio"/>

Buttons: Refresh, Connect, Close, Signal Survey

To connect with the selected SSID. This function is available only in Client, WISP Router, and Repeater modes only.

For antenna alignment. It will display and update the Signal Strength continuously

Click here to select SSID for Association or Signal Survey

4.2.4 Signal Survey

Operation Mode -> Setup -> Site Survey -> Signal Survey

The Signal Survey will continuously display the SIGNAL STRENGTH value of the selected SSID for antenna alignment purpose. To use Signal Survey function, please enter the "Site Survey" function first; please refer to the instruction in the above section. Once you select the ESSID and click on the "Signal Survey" button, the following screen will appear.

Signal Survey						
SSID	BSSID	Channel	Type	Encrypt	Signal	
airlive2	00:e0:4c:81:86:23	11 (B+G)	AP	no	24	

- **BSSID:** This is the remote AP's MAC address.
- **Channel:** The current scanned channel
- **Signal Strength:** This is signal strength number in percentage in 0 to 100 scale. The higher the number, the better signal.

4.2.5 Hide SSID

Wireless Settings -> Hide SSID

When this function is enabled, the wireless network will become invisible. Only people who know the SSID name can join the network. It is recommended to use this feature to protect the network from intruders. However, once this function is enabled, it might be necessary to configure the wireless connection manually. This option is available in AP mode, AP Router mode, and Repeater modes only.

4.2.6 Radio Mode

Wireless Settings -> Radio Mode

AirMax2 has 3 different options for WLAN transmission. All devices in the same network should use the same WLAN mode.

- **802.11g/b:** The radio will auto adjust between 11g and 11b mode. It is recommended to use this mode.
- **802.11g Only:** The radio will only connect at 11g mode.
- **802.11b Only:** The radio will only connect at 11b mode.

4.2.7 Channel

Wireless Settings -> Channel

The channel is the frequency range used by radio. In 802.11g/b standard, there are maximum of 14 Channels. However, the available channels in each country are dependant on the local regulation. If you are living in Europe, you can use channel 1 to 13. If you are living in the United States, you can use channel 1 to 11.

Each wireless channel takes between 22 to 25MHz of frequency width. But the channels are only 5MHz apart. Therefore, only every 5 channels can be free of interference with each other. It is recommended that you can do a site survey to find about what channels are used by surrounding AP and choose a channel that is not used by other APs.

Channel	Frequency (MHz)	U.S.A.	Europe
1	2412	○	○
2	2417	○	○
3	2422	○	○
4	2427	○	○
5	2432	○	○
6	2437	○	○
7	2442	○	○
8	2447	○	○
9	2452	○	○
10	2457	○	○
11	2462	○	○
12	2467	-	○
13	2472	-	○
14	2484	-	-

4.2.8 Client Mode Security Settings

Wireless Settings -> Security Settings

Security settings allow you to use encryption to secure your data from eavesdropping. You can select different security policy to provide association authentication and/or data encryption. The AIRMAX2 features various security policies including WEP, 802.1x, WPA, WPA Personal, WPA2, WPA2 Personal , WPA Mixed.

WEP

WEP Encryption is the oldest and most available encryption method. However, it is also the least secure.

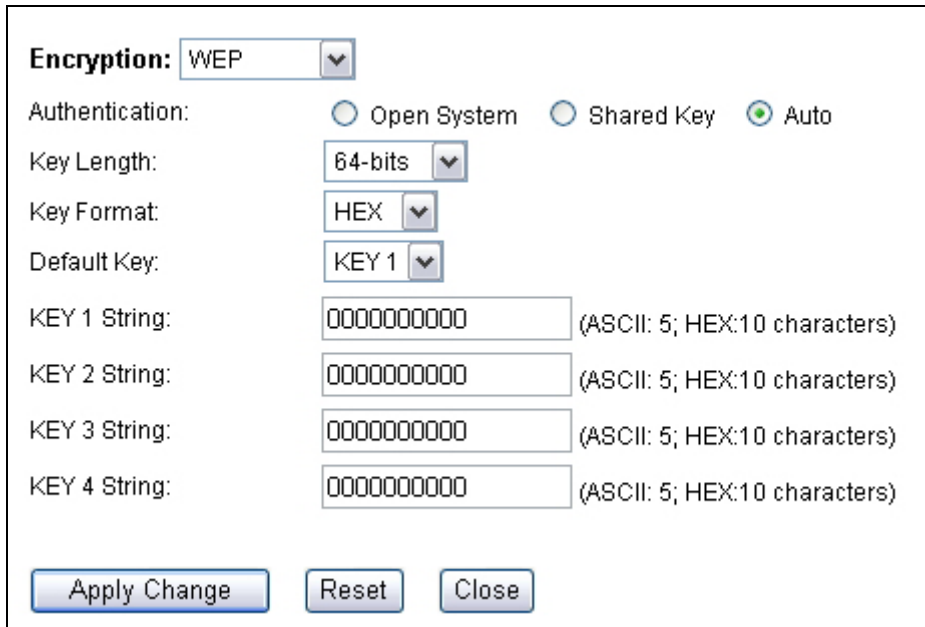

Encryption: WEP
 Authentication: Open System Shared Key Auto
 Key Length: 64-bits
 Key Format: HEX
 Default Key: KEY 1
 KEY 1 String: 0000000000 (ASCII: 5; HEX:10 characters)
 KEY 2 String: 0000000000 (ASCII: 5; HEX:10 characters)
 KEY 3 String: 0000000000 (ASCII: 5; HEX:10 characters)
 KEY 4 String: 0000000000 (ASCII: 5; HEX:10 characters)
 Apply Change Reset Close

- **Select one of the WEP key for wireless network:** There are total of 4 possible keys for WEP encryption. You need to choose which key will be used for encryption. All wireless devices on the same network have to use the same settings. We recommend using WEP Key 1 as in default setting.
- **Authentication:** 2 types of Authentication are offered. Open system and Shared key. If you are not sure which one to use, please select “Auto”.
- **Key Length:** The AIRMAX2 offers 64bit and 128 bit for WEP key length. The longer the Key Length, the more secure the encryption is.
- **Key Type:** 2 types are available: ASCII and HEX. ASCII is a string of ASCII code including alphabetical characters, space, signs and numbers (i.e. “airlivepass12”). HEX is a string of 16-bit hexadecimal digits (0..9, a, b, c, d, e, f). All wireless devices on the network must match the exact key length and Key type. Some Wireless clients only allow HEX type for WEP.
- **ASCII-64:** This is a key with 64-bit key length of ASCII type. Please enter **5** ASCII Characters if you choose this option. For example, “passw”
- **HEX-64:** This is a key with 64-bit key length of HEX type. Please enter **10** Hexadecimal digits if you choose this option. For example, “12345abcdef”
- **ASCII-128:** This is a key with 64-bit key length of ASCII type. Please enter **13** ASCII Characters if you choose this option. For example, “airlivewepkey”
- **HEX-128:** This is a key with 128-bit key length of HEX type. Please enter **26**

Hexadecimal digits if you choose this option. For example, "1234567890abcdef1234567890"

WPA-PSK, WPA2-PSK, WPA-AUTO

Wi-Fi Protected Access (WPA) introduces the Temporal Key Integrity Protocol (TKIP) that provides added security. WPA2 adds full support for 802.11i standard and the CCMP (AES Encryption). The WPA Mixed tries to authenticate wireless clients using both WPA-PSK or WPA2-PSK.

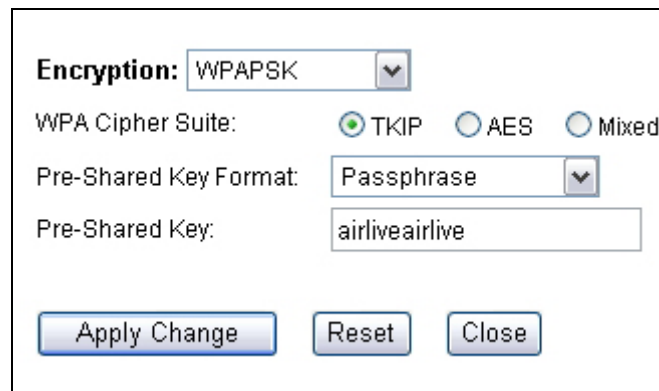

The screenshot shows a configuration window for WPA settings. It includes a dropdown menu for 'Encryption' set to 'WPAPSK', radio buttons for 'WPA Cipher Suite' with 'TKIP' selected, a dropdown for 'Pre-Shared Key Format' set to 'Passphrase', and a text field for 'Pre-Shared Key' containing 'airliveairlive'. At the bottom are 'Apply Change', 'Reset', and 'Close' buttons.

- **Encryption Type:** There are two encryption types **TKIP** and **CCMP (AES)**. While CCMP provides better security than TKIP, some wireless client stations may not be equipped with the hardware to support it. You can select **Mixed** to allow TKIP clients and CCMP clients to connect to the Access Point at the same time.
- **Pre-Shared Key Format:** You can select between Passphrase(ASCII) or HEX format. Please select Passphrase if you are not sure what to use.
- **Pre-Shared Key:** Enter the password key here..

4.2.9 AP Mode Security Settings

Wireless Settings -> Security Settings

Security settings allow you to use encryption to secure your data from eavesdropping. You can select different security policy to provide association authentication and/or data encryption. The AIRMAX2 features various security policies including WEP, 802.1x, WPA, WPA Personal, WPA2, WPA2 Personal, WPA Mixed.

WEP

WEP Encryption is the oldest and most available encryption method. However, it is also the least secure.

Encryption: WEP ▼

Authentication: Open System Shared Key Auto

Key Length: 64-bits ▼

Key Format: HEX ▼

Default Key: KEY 1 ▼

KEY 1 String: (ASCII: 5; HEX:10 characters)

KEY 2 String: (ASCII: 5; HEX:10 characters)

KEY 3 String: (ASCII: 5; HEX:10 characters)

KEY 4 String: (ASCII: 5; HEX:10 characters)

Apply Change
Reset
Close

- **Select one of the WEP key for wireless network:** There are total of 4 possible keys for WEP encryption. You need to choose which key will be used for encryption. All wireless devices on the same network have to use the same settings. We recommend using WEP Key 1 as in default setting.

- **Authentication:** 2 types of Authentication are offered. Open system and Shared key. If you are not sure which one to use, please select “Auto”.
- **Key Length:** The AIRMAX2 offers 64bit and 128 bit for WEP key length. The longer the Key Length, the more secure the encryption is.
- **Key Type:** 2 types are available: ASCII and HEX. ASCII is a string of ASCII code including alphabetical characters, space, signs and numbers (i.e. “airlivepass12”). HEX is a string of 16-bit hexadecimal digits (0..9, a, b, c, d, e, f). All wireless devices on the network must match the exact key length and Key type. Some Wireless clients only allow HEX type for WEP.
- **ASCII-64:** This is a key with 64-bit key length of ASCII type. Please enter **5** ASCII Characters if you choose this option. For example, “passw”
- **HEX-64:** This is a key with 64-bit key length of HEX type. Please enter **10** Hexadecimal digits if you choose this option. For example, “12345abcdef”
- **ASCII-128:** This is a key with 64-bit key length of ASCII type. Please enter **13** ASCII Characters if you choose this option. For example, “airlivewepkey”
- **HEX-128:** This is a key with 128-bit key length of HEX type. Please enter **26** Hexadecimal digits if you choose this option. For example, “1234567890abcdef1234567890”

WPA-Personal, WPA2-Personal, WPA-Mixed (Pre-Shared Key)

The WPA Personal is also known as “WPA-PSK” encryption. Wi-Fi Protected Access (WPA) introduces the Temporal Key Integrity Protocol (TKIP) that provides added security. WPA2 adds full support for 802.11i standard and the CCMP (AES Encryption). The WPA-Mixed tries to authenticate wireless clients using both WPA-PSK or WPA2-PSK.

Radio 2 Security Setup

Encryption: WPA ▼
Authentication: Personal(Pre-Shared Key) ▼
WPA Cipher Suite: TKIP AES Mixed
Pre-Shared Key Format: Passphrase ▼
Pre-Shared Key:

- **Encryption Type:** There are two encryption types **TKIP** and **CCMP (AES)**. While CCMP provides better security than TKIP, some wireless client stations may not be equipped with the hardware to support it. You can select **Mixed** to allow TKIP clients and CCMP clients to connect to the Access Point at the same time.
- **Pre-Shared Key Format:** You can select between Passphrase(ASCII) or HEX format. Please select Passphrase if you are not sure what to use.
- **Pre-Shared Key:** Enter the password key here..

WPA-Enterprise, WPA2-Enterprise, WPA-Mixed Enterprise (Radius)

Wi-Fi Protected Access (WPA) Enterprise uses Radius Server as the authenticator. WPA2 adds full support for 802.11i standard and the CCMP (AES Encryption). The WPA-Mixed tries to authenticate wireless clients using both WPA or WPA2.

Encryption: WPA ▼
Authentication: Enterprise(RADIUS) ▼
WPA Cipher Suite: TKIP AES Mixed
Server IP Address: (xxx.xxx.xxx.xxx)
Server Port: (1024-65535)
Server Password:

4.2.10 Client Isolation

Wireless Settings -> Client Isolation

The default setting is “Disable”. When enabled, the wireless clients will not be able to communicate with each other. This feature is useful for public WiFi, WISP operators, and Hotspot operators.

4.2.11 Data Rate

Wireless Settings -> Data Rate

Data Rate is the physical speed of transmission. The default setting is Auto. In “Auto” mode, the data rate will adjust according to the connection condition. It is advised to put the data rate in Auto.

However, you can also force the radio to operate at specific data rate. The highest for 11g/b and 11g Radio mode is 54Mbps.

4.2.12 Tx Output Power

Wireless Settings -> Tx Output Power

You can adjust the transmit output power of the AirMax2's radio. The higher the output power, the more distance AirMax2 can deliver. However, it is advised that you use just enough output power so it will not create excessive interference for the environment. Also, using too much power at close distance can create serious performance drop due to signal distortion.

If you are not getting good signal, you can try to increase the output power. However; if your signal appear to be strong but the performance is low., it is advised to reduce the output power.

Please make sure not to exceed the legal limit of output power in your country. For EU, it is limited to 20dBm. For U.S.A., the limit is 23dBm.

4.2.13 Clear Signal Technology

Wireless Settings -> ClearSignal Technology

The default setting is “Off”. ClearSignal Technology uses the combination of sensitivity adjustment and hardware filtering to reduce the effect of interference. If you are experiencing unstable performance caused by interference, please try to turn on this setting. However, turn on this function will also reduce the radio’s sensitivity. Therefore, it is advised only in heavy interference condition.

4.2.14 Antenna Select

Wireless Settings -> Antenna Select

You can choose to use the built-in Internal Antenna or external antenna through this setting. Please remember to reboot the AP after “Apply Changes” to take effect.

4.2.15 Auto Clone MAC (Client Mode Only)

Wireless Settings -> Auto Clone MAC

When this function is selected, the AirMax2(in client mode) will use MAC address of the first PC that went through the LAN port as the wireless MAC address.

4.2.16 Manual MAC Clone (Client Mode Only)

Wireless Settings -> Manual MAC Clone

If you wish to change the wireless MAC address of the AirMax2 manually, please enter the MAC address here.

4.2.17 Access Control

Wireless Settings -> Access Control

The AIRMAX2 allows you to define a list of MAC addresses that are allowed or denied to access the wireless network. This function is available only for Access Point and AP Router modes. This function is available only for Access Point and Gateway modes.

Wireless Access Control

Wireless Access Control Mode:

MAC Address: Comment:

Current Access Control List:

MAC Address	Comment	Select

- Disable:** When selected, no MAC address filtering will be performed.
- Allow list:** When selected, data traffic from only the specified devices in the table will be allowed in the network.
- Deny list:** When selected, data traffic from the devices specified in the table will be denied/discarded by the network.

4.3 LED Threshold

Wireless Settings -> LED Threshold

This function is available only for Client, Bridge, and WISP Router mode.

The AirMax2 is equipped with 2 LEDs on the Left side of the housing to indicate the signal strength of current connection. It is very useful in helping you to align the antenna. The signal level are classified into 4 levels, you can change the Thresholds (dividing line) between levels in this setting. The unit for Signal Strength is in Percentage from 0 to 100. The higher the value, the stronger the signal.

- No Signal:** When signal strength is less than “Weak Signal Threshold”(for example, 20%) . Both LED are off.
- Weak Signal:** When signal strength is greater or equal than the “Weak Signal Threshold”(for example 35%). Only the Blue LED is on.
- Strong Signal:** When signal strength is greater or equal than the “Strong Signal Threshold”(for example 60%). Only the Green LED is on.
- Full Signal:** When signal strength is greater or equal than the “Full Signal Threshold”(for example 75%). Both Green and Blue LEDs are on

		Threshold
	Weak signal:	<input type="text" value="30"/> %
	Strong signal:	<input type="text" value="50"/> %
	Full signal:	<input type="text" value="70"/> %
<input type="button" value="Apply Changes"/> <input type="button" value="Reset"/> <input type="button" value="Back"/>		

 The Signal LEDs are working only when the connection is established. Therefore, please make sure all wireless settings are correct and the connection is established.

4.4 Advance Settings

Wireless Advanced Settings

Alias Name:

Fragment Threshold: (256-2346)

RTS Threshold: (0-2347)

Beacon Interval: (20-1024 ms)

Inactivity Time: (101-60480000 10ms)

Preamble Type: Long Preamble Short Preamble

IAPP: Enabled Disabled

802.11g Protection: Enabled Disabled

Ack timeout: (0-255, 0:Auto adjustment, Unit: 4µsec)

- **Alias Name:** This function is available only for AP and AP Router mode. You can define the name of the AP in this field.
- **Fragmentation:** When the size of a unicast frame exceeds the fragmentation threshold, it will be fragmented before the transmission. It should have a value of

256-2346 bytes, with a default of 2346. If you experience a high packet error rate, you should slightly decrease the Fragmentation Threshold.

- **RTS Threshold:** RTS/CTS frames are used to gain control of the medium for transmission. Any unicast (data or control) frames larger than specified RTS threshold must be transmitted following the RTS/CTS handshake exchange mechanism. The RTS threshold should have a value between 256-2347 bytes, with a default of **2347**. It is recommended that this value does not deviate from the default too much.
- **Beacon Interval:** The device broadcasts beacon frames regularly to announce its existence. The beacon Interval specifies how often beacon frames are transmitted in time unit of milliseconds. The default value is **100**, and a valid value should be between 1 and 65,535.
- **Inactivity Time:** The wireless client will be dropped from the network when they are inactive for this amount of time.
- **AckTimeOut:** When a packet is sent out from one wireless station to the other, it will wait for an Acknowledgement frame from the remote station. The station will only wait for a certain amount of time, this time is called the ACK timeout. In most conditions, please put ACKtimeout value at zero(default value). The AP will calculate the ACKtimeout automatically when the value is zero. However, you can also enter the ACKtimeout manually.
- **Preamble Type:** A preamble is a signal used in wireless environment to synchronize the transmitting timing including Synchronization and Start frame delimiter. In a "noisy" network environment, the Preamble Type should be set to Long Preamble. The Short Preamble is intended for applications where minimum overhead and maximum performance is desired. If in a "noisy" network environment, the performance will be decreased.
- **IAPP:** IAPP (Inter Access Point Protocol) is designed for the enforcement of unique association throughout a ESS (Extended Service Set) and a secure exchange of station's security context between current access point (AP) and new AP during handoff period.
- **BG Protection:** The 802.11g standard includes a protection mechanism to ensure mixed 802.11b and 802.11g operation. If there is no such kind of mechanism exists, the two kinds of standards may mutually interfere and decrease network's performance..

4.5 Bridge Mode Settings

4.5.1 WDS Settings

For Bridge network, it is required to enter the Wireless MAC address of all remote bridges that is connect directly to your AirMax2. The wireless MAC address is also known as BSSID that is display on your site survey result.

Enable WDS

MAC Address: (xxxxxxxxxxxx)

Comment: (WDS device information)

Current WDS Device List:

MAC Address	Comment	Select

- **MAC Address:** Please enter the Wireless MAC address or BSSID of the remote Bridge. You can usually find it at remote Bridge's device label.
- **Comment:** If you input anything that will help remind you about which remote Bridge it is.

4.5.2 WDS Security

Operation Mode -> Setup -> Security Settings

Security settings allow you to use encryption to secure your data from eavesdropping. You can select different security policy to provide association authentication and/or data encryption. AirMax2 features various security policies including WEP, 802.1x, WPA, WPA Personal, WPA2, WPA2 Personal , WPA Mixed.

WEP

WEP Encryption is the oldest and most available encryption method. However, it is also the least secure.

Encryption:

Authentication: Open System Shared Key Auto

Key Length:

Key Format:

Default Key:

KEY 1 String: (ASCII: 5; HEX:10 characters)

KEY 2 String: (ASCII: 5; HEX:10 characters)

KEY 3 String: (ASCII: 5; HEX:10 characters)

KEY 4 String: (ASCII: 5; HEX:10 characters)

- **Select one of the WEP key for wireless network:** There are total of 4 possible keys for WEP encryption. You need to choose which key will be used for encryption. All wireless devices on the same network have to use the same settings. We recommend using WEP Key 1 as in default setting.

- **Authentication:** 2 types of Authentication are offered. Open system and Shared key. If you are not sure which one to use, please select "Auto".
- **Key Length:** The AIRMAX2 offers 64bit and 128 bit for WEP key length. The longer the Key Length, the more secure the encryption is.
- **Key Type:** 2 types are available: ASCII and HEX. ASCII is a string of ASCII code including alphabetical characters, space, signs and numbers (i.e. "airlivepass12"). HEX is a string of 16-bit hexadecimal digits (0..9, a, b, c, d, e, f). All wireless devices on the network must match the exact key length and Key type. Some Wireless clients only allow HEX type for WEP.
- **ASCII-64:** This is a key with 64-bit key length of ASCII type. Please enter **5** ASCII Characters if you choose this option. For example, "passw"
- **HEX-64:** This is a key with 64-bit key length of HEX type. Please enter **10** Hexadecimal digits if you choose this option. For example, "12345abcdef"
- **ASCII-128:** This is a key with 64-bit key length of ASCII type. Please enter **13** ASCII Characters if you choose this option. For example, "airlivewepkey"
- **HEX-128:** This is a key with 128-bit key length of HEX type. Please enter **26** Hexadecimal digits if you choose this option. For example, "1234567890abcdef1234567890"

WPA-PSK, WPA2-PSK

Wi-Fi Protected Access (WPA) introduces the Temporal Key Integrity Protocol (TKIP) that provides added security. WPA2 adds full support for 802.11i standard and the CCMP (AES Encryption). The WPA Mixed tries to authenticate wireless clients using both WPA-PSK or WPA2-PSK.

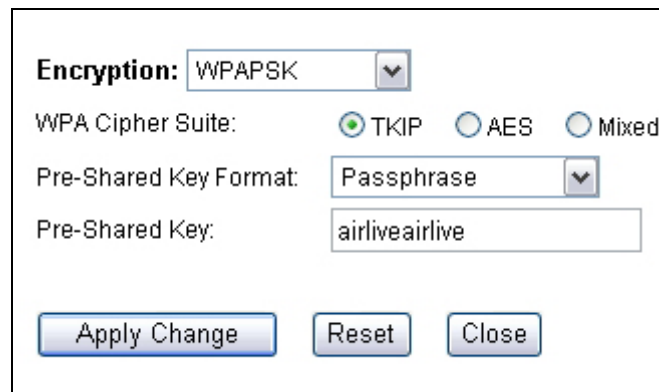

The screenshot shows a configuration window for WPA-PSK/WPA2-PSK. It includes the following fields and controls:

- Encryption:** A dropdown menu set to WPAPSK.
- WPA Cipher Suite:** Three radio buttons: TKIP (selected), AES, and Mixed.
- Pre-Shared Key Format:** A dropdown menu set to Passphrase.
- Pre-Shared Key:** A text input field containing the value 'airliveairlive'.
- Buttons:** 'Apply Change', 'Reset', and 'Close'.

- **Encryption Type:** There are two encryption types **TKIP** and **CCMP (AES)**. While CCMP provides better security than TKIP, some wireless client stations may not be equipped with the hardware to support it. You can select **Mixed** to allow TKIP clients and CCMP clients to connect to the Access Point at the same time.
- **Pre-Shared Key Format:** You can select between Passphrase(ASCII) or HEX format. Please select Passphrase if you are not sure what to use.
- **Pre-Shared Key:** Enter the password key here..

5

Wireless Menu: Router Mode Settings

In this chapter, we will explain about Router mode settings in web management interface. The Router mode settings are available in WISP Router, AP Router, and WISP+Repeater mode. Please be sure to read through Chapter 3's "Introduction to Web Management" and "Initial Configurations" first.

5.1 Router Mode Settings under Wireless Menu

When you choose AP Router, WISP Router, or WISP+Universal modes; the Wireless Setting page will feature router mode functions as indicated on the image below.

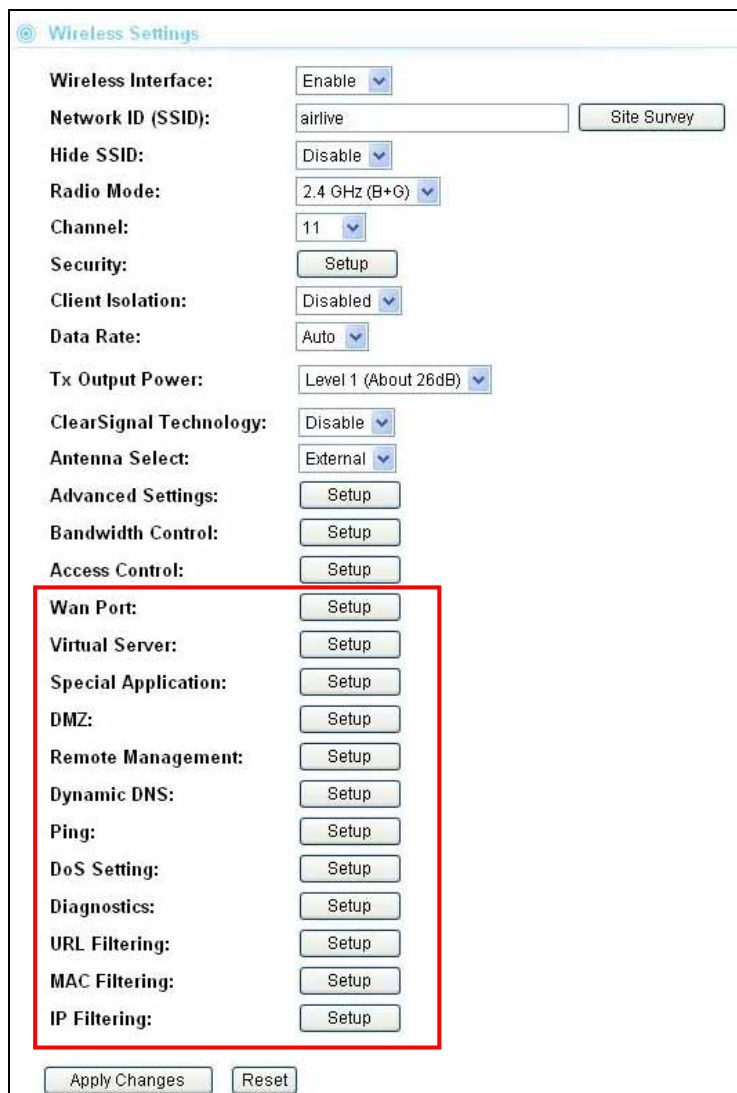

Wireless Settings	
Wireless Interface:	Enable <input type="button" value="v"/>
Network ID (SSID):	airlive <input type="button" value="Site Survey"/>
Hide SSID:	Disable <input type="button" value="v"/>
Radio Mode:	2.4 GHz (B+G) <input type="button" value="v"/>
Channel:	11 <input type="button" value="v"/>
Security:	<input type="button" value="Setup"/>
Client Isolation:	Disabled <input type="button" value="v"/>
Data Rate:	Auto <input type="button" value="v"/>
Tx Output Power:	Level 1 (About 26dB) <input type="button" value="v"/>
ClearSignal Technology:	Disable <input type="button" value="v"/>
Antenna Select:	External <input type="button" value="v"/>
Advanced Settings:	<input type="button" value="Setup"/>
Bandwidth Control:	<input type="button" value="Setup"/>
Access Control:	<input type="button" value="Setup"/>
Wan Port:	<input type="button" value="Setup"/>
Virtual Server:	<input type="button" value="Setup"/>
Special Application:	<input type="button" value="Setup"/>
DMZ:	<input type="button" value="Setup"/>
Remote Management:	<input type="button" value="Setup"/>
Dynamic DNS:	<input type="button" value="Setup"/>
Ping:	<input type="button" value="Setup"/>
DoS Setting:	<input type="button" value="Setup"/>
Diagnostics:	<input type="button" value="Setup"/>
URL Filtering:	<input type="button" value="Setup"/>
MAC Filtering:	<input type="button" value="Setup"/>
IP Filtering:	<input type="button" value="Setup"/>
<input type="button" value="Apply Changes"/> <input type="button" value="Reset"/>	

5.1.1 WAN Port

Operation Mode -> Setup -> WAN Port

The AIRMAX2 support different authentication and IP assignment standards for the WAN port. It includes fixed IP, DHCP, PPPoE, PPTP, L2TP, and Big Pond protocols. Please consult with your ISP about what authentication type is used for the WAN port connection.

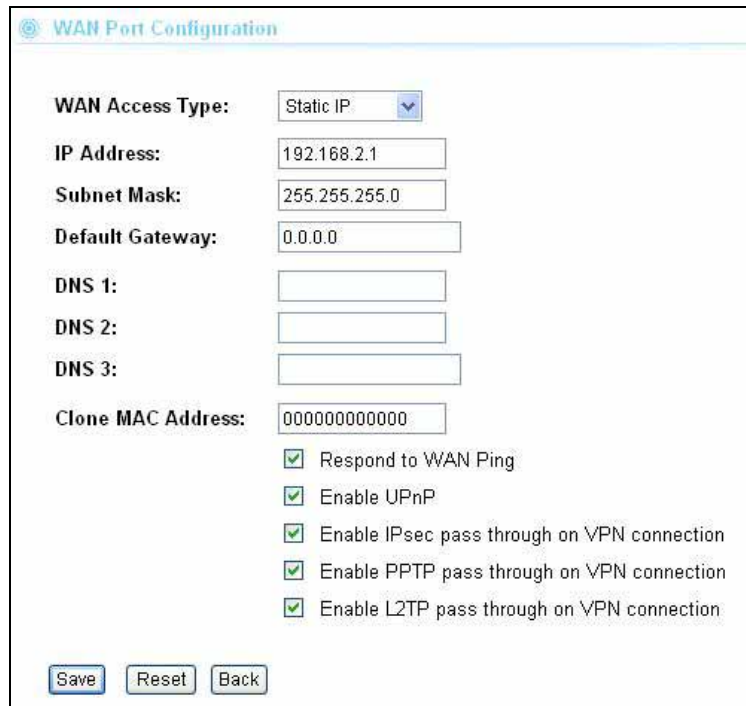

WAN Port Configuration

WAN Access Type: Static IP

IP Address: 192.168.2.1

Subnet Mask: 255.255.255.0

Default Gateway: 0.0.0.0

DNS 1:

DNS 2:

DNS 3:

Clone MAC Address: 000000000000

Respond to WAN Ping

Enable UPnP

Enable IPsec pass through on VPN connection

Enable PPTP pass through on VPN connection

Enable L2TP pass through on VPN connection

Save Reset Back

- **Clone MAC Address:** In this place, you can assign a MAC address for the WAN port. In case of WISP mode, it is Radio1's MAC address. For Gateway mode, it is the WAN/LAN1 MAC address.
- **Enable UPnP:** Check this field will enable Universal Plug n Play protocol
- **Enable Web Server Access on WAN:** Check this field will enable remote management from WAN side.

5.1.2 Virtual Server Settings

Virtual server allows you to specify one or more applications running on server computers on the LAN that may be accessed by any Internet user. Internet data destined for the specified public port will be directed to the specified private port number on the LAN client with the specified private IP address.

If you want to allow your web server, ftp server, or email server to be accessible from Internet, you would need to open specific port on the virtual server to your local IP address.

Virtual Servers

Enable Virtual Servers

Servers:

Local IP Address:

Protocol:

Port Range: -

Description:

Current Virtual Servers Table:

Local IP Address	Protocol	Port Range	Description	Select
<input type="button" value="Delete Selected"/> <input type="button" value="Delete All"/> <input type="button" value="Reset"/> <input type="button" value="Back"/>				

For a list of most frequent used TCP and UDP ports. Please visit http://en.wikipedia.org/wiki/List_of_TCP_and_UDP_port_numbers

5.1.2 DMZ

Advanced Settings >> Multiple DMZ

DMZ opens all TCP/UDP ports to particular IP address on the LAN side. It allows setting up servers behind the AIRMAX2.

DMZ

Enable DMZ

DMZ Host IP Address:

5.1.3 Dynamic DNS

Dynamic Domain Name System. An algorithm that allows the use of dynamic IP address for hosting Internet Server. A DDNS service provides each user account with a domain name. The AIRMAX2 support “Dyndns” and “TZO” service.

Dynamic DNS Setting

Enable DDNS

Service Provider:

Domain Name:

User Name/Email:

Password/Key:

Result:

Note:
 For TZO, you can have a 30 days free trial [here](#) or manage your TZO account in [control panel](#).
 For DynDNS, you can create your DynDNS account [here](#).

5.1.4 DoS (Denial of Service)

Denial of Service is a type of network attack that floods the network with useless traffic. Many DoS attacks, such as the Ping of Death and Teardrop attacks, exploit limitations in the TCP/IP protocols.

Denial of Service

Enable DoS Prevention

<input type="checkbox"/> Whole System Flood: SYN	<input type="text" value="50"/>	Packets/Second
<input type="checkbox"/> Whole System Flood: FIN	<input type="text" value="50"/>	Packets/Second
<input type="checkbox"/> Whole System Flood: UDP	<input type="text" value="50"/>	Packets/Second
<input type="checkbox"/> Whole System Flood: ICMP	<input type="text" value="50"/>	Packets/Second
<input type="checkbox"/> Per-Source IP Flood: SYN	<input type="text" value="50"/>	Packets/Second
<input type="checkbox"/> Per-Source IP Flood: FIN	<input type="text" value="50"/>	Packets/Second
<input type="checkbox"/> Per-Source IP Flood: UDP	<input type="text" value="50"/>	Packets/Second
<input type="checkbox"/> Per-Source IP Flood: ICMP	<input type="text" value="50"/>	Packets/Second
<input type="checkbox"/> TCP/UDP PortScan	<input type="text" value="Low"/>	Sensitivity
<input type="checkbox"/> ICMP Smurf		
<input type="checkbox"/> IP Land		
<input type="checkbox"/> IP Spoof		
<input type="checkbox"/> IP TearDrop		
<input type="checkbox"/> PingOfDeath		
<input type="checkbox"/> TCP Scan		
<input type="checkbox"/> TCP SynWithData		
<input type="checkbox"/> UDP Bomb		
<input type="checkbox"/> UDP EchoChargen		

Enable Source IP Blocking **Block time (sec)**

5.1.5 URL Filter

The AIRMAX2 provide URL filter function to stop access to certain website. It is especially useful for parents to stop children from accessing some websites.



URL Filtering

Enable URL Filtering

URL Address:

Apply Changes Reset

Current Filter Table:

URL Address	Select

Delete Selected Delete All Reset Back

5.1.6 MAC Filter

MAC filter can filter out traffic from certain MAC addresses. It can prevent access to internet from certain station in the local LAN.

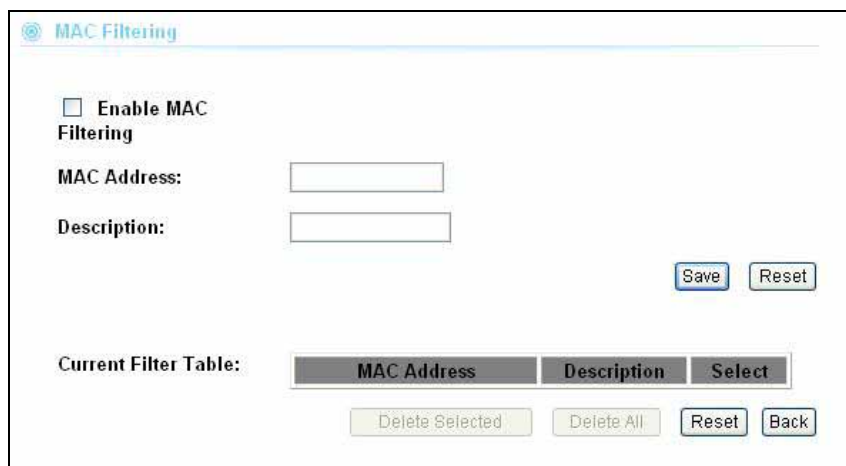

MAC Filtering

Enable MAC Filtering

MAC Address:

Description:

Save Reset

Current Filter Table:

MAC Address	Description	Select

Delete Selected Delete All Reset Back

5.1.7 IP Filter

IP filtering allows you to block certain IP addresses from accessing the network.

IP Filtering

Enable IP Filtering

Local IP Address:

Protocol:

Description:

Current Filter Table:

Local IP Address	Protocol	Description	Select

5.1.8 Special Applications

This function enables special Internet audio, video, or game servers that require “Port Trigger” function.

Special Applications

Name	Incoming Type	Incoming Start Port	Incoming End Port	Trigger Type	Trigger Start Port	Trigger End Port	Enable
QuickTime 4	UDP	6970	6999	UDP	554	554	<input type="checkbox"/>
Dialpad	UDP	51200	51201	UDP	7175	7175	<input type="checkbox"/>
Paltalk	UDP	2090	2091	UDP	8200	8700	<input type="checkbox"/>
Battle.net	TCP	6112	6119	TCP	6112	6112	<input type="checkbox"/>
	TCP	0	0	TCP	0	0	<input type="checkbox"/>
	TCP	0	0	TCP	0	0	<input type="checkbox"/>
	TCP	0	0	TCP	0	0	<input type="checkbox"/>
	TCP	0	0	TCP	0	0	<input type="checkbox"/>

5.1.9 Diagnostic (DNS Lookup)

The DNS Lookup can look up for information about a domain name. It will display the IP address and DNS server of a specific domain.



The screenshot shows the 'Network Diagnostics - DNS Lookup' page. It features a text input field labeled 'Domain name/URL:' with a 'Start Lookup' button to its right. Below the input field is a large empty text area for results. At the bottom left, there is a 'Back' button.

5.1.10 PING

The PING function allow you to test whether a remote IP address is accessible from the AirMax2. You can enter either IP address or Domain Name in the foeld.

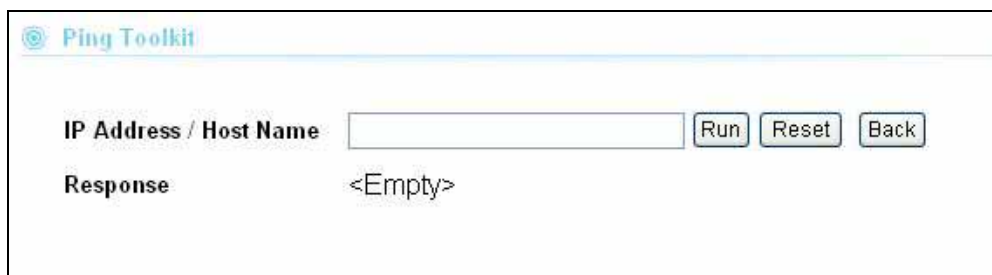

The screenshot shows the 'Ping Toolkit' page. It has a text input field labeled 'IP Address / Host Name' with 'Run', 'Reset', and 'Back' buttons to its right. Below the input field, the 'Response' is displayed as '<Empty>'.

5.1.11 Remote Management

You can enable the web management to allow the AirMax2 be managed from internet. You can change the management port number and/or enable the SSH access from WAN.



The screenshot shows the 'Remote Management' page. It features a checked checkbox for 'Enable Web Server Access via WAN'. Below this, there is a 'Port Number' input field containing the value '80'. There is also an unchecked checkbox for 'Enable SSH via WAN'. At the bottom, there are 'Save', 'Reset', and 'Back' buttons.

6

System Configurations

In this chapter, we will explain about *System Configurations* in web management interface. Please be sure to read through Chapter 3's "*Introduction to Web Management*" and "*Initial Configurations*" first.

6.1 Menu Structure

When you click on the "System Configuration" menu on the top menu bar, the following screen will appear. The system configuration includes all non-wireless settings. We will explain their functions here.

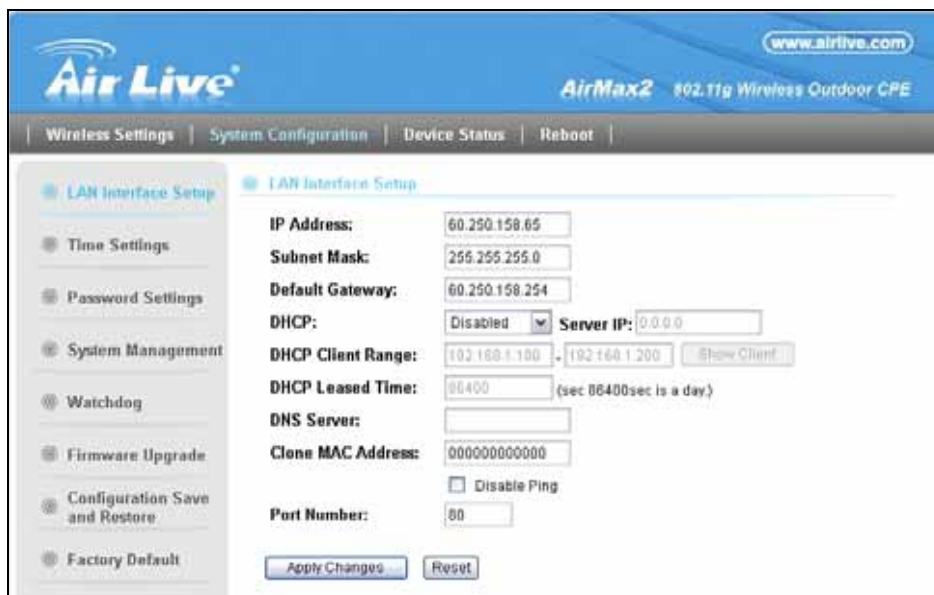

The screenshot displays the Air Live web management interface for an AirMax2 802.11g Wireless Outdoor CPE. The top navigation bar includes links for Wireless Settings, System Configuration, Device Status, and Reboot. The main content area is titled "LAN Interface Setup" and contains the following configuration fields:

- IP Address:** 60.250.158.65
- Subnet Mask:** 255.255.255.0
- Default Gateway:** 60.250.158.254
- DHCP:** Disabled (dropdown menu)
- Server IP:** 0.0.0.0
- DHCP Client Range:** 192.168.1.100 - 192.168.1.200 (with a "Show Client" button)
- DHCP Leased Time:** 86400 (sec 86400sec is a day)
- DNS Server:** (empty field)
- Clone MAC Address:** 000000000000
- Disable Ping
- Port Number:** 80

At the bottom of the configuration area, there are two buttons: "Apply Changes" and "Reset".

6.2 LAN Interface Setup

System Configurations>> *LAN Interface Setup*

This menu is where you can configuration all the aspect about LAN interface including IP address, DHCP server settings..etc.

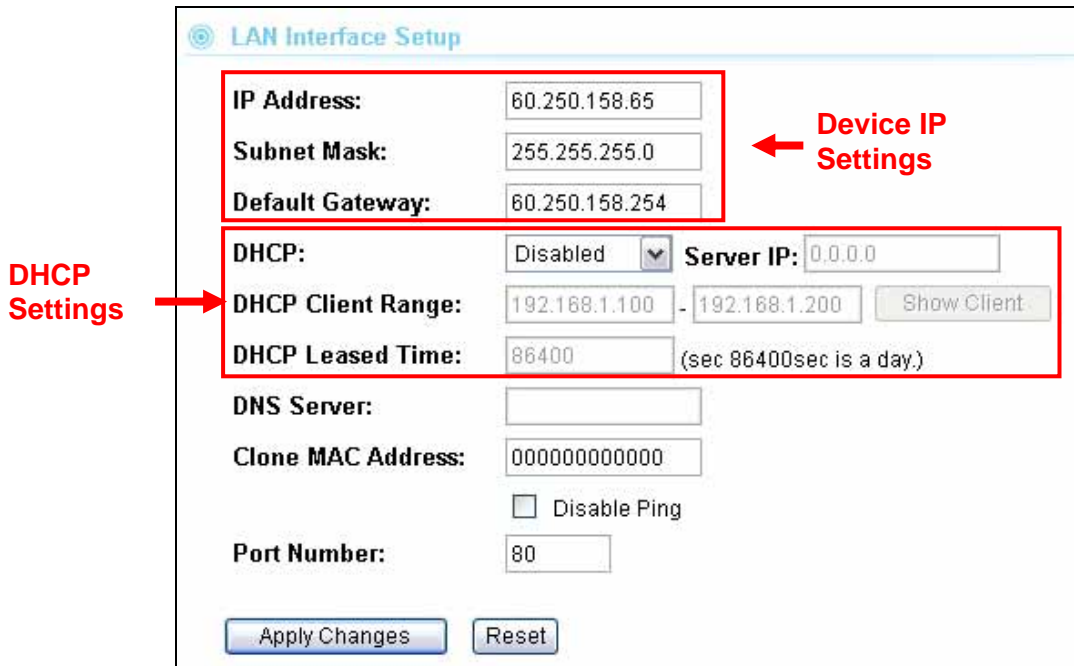

LAN Interface Setup

IP Address: 60.250.158.85
Subnet Mask: 255.255.255.0
Default Gateway: 60.250.158.254

DHCP: Disabled
DHCP Client Range: 192.168.1.100 - 192.168.1.200
DHCP Leased Time: 86400 (sec 86400sec is a day.)

DNS Server:
Clone MAC Address: 000000000000
 Disable Ping

Port Number: 80

6.2.1 DHCP Settings

- **DHCP Service:** You can enable or disable DHCP server here.
 - **Disable:** Disable DHCP server
 - **Client:** The LAN interface will get IP address from DHCP server
 - **Server(default);** The AIRMAX2 will act as DHCP server to provide IP addresses to the clients on the LAN/Wireless interface. By default, the DHCP server is on.
 - **DCHP Relay Agent:** This function should be chosen in Universal Repeater mode in order to assign IP address from remote DHCP server.
- **DHCP Client Range:** You can define the IP pool from which the DHCP clients can get IP address.. Click on "Show Clients" to see the current DHCP client table.
- **DHCP Release Time:** You can define how long the AIRMAX2 will reserve IP address for a particular PC or Device here.

6.2.2 Clone MAC Address

You can change the MAC address of your LAN port to other value here.

6.2.3 Disable PING

If you do not wish the AIRMAX2 to respond to remote PING command, please disable it here.

6.2.4 Add DHCP Static Lease Client

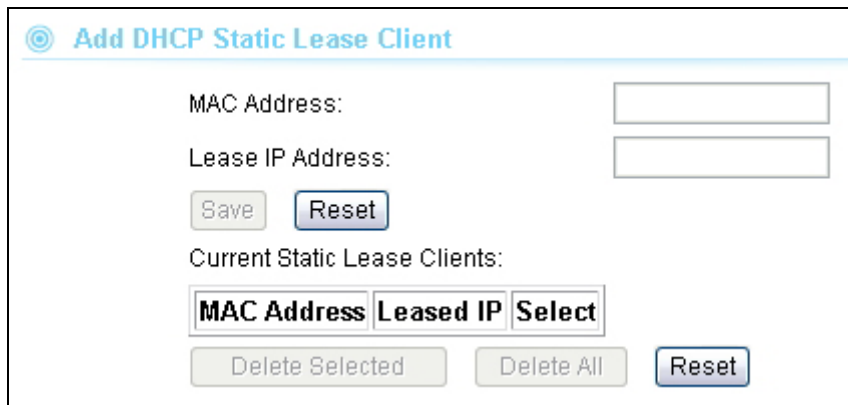

If you want to lock IP address to a MAC address, you should add DHCP clients to the “Static Lease Client”. Up to 40 entries can be entered. Below is the procedure for adding an entry:

1. Enter the MAC address of the device
2. Enter the IP address of the device
3. Click on the “Add” button

6.3 Time Settings

System Configuration ->Time Settings

You can set the NTP Time Server for your AIRMAX2’s internal clock here. You can use NTP server function so your AIRMAX2 will check with NTP to set time automatically upon each startup. Thus, it prevents the clock losing track of time during reboot or power outage.



Below is the procedure to set your NTP server

1. Check the “Enable NTP Client Update”

2. Select your time Zone
3. Select your NTP server
4. Click on “Apply Change”

6.4 Password Settings

System Configuration -> Password Settings

The AIRMAX2’s password protection is turned off by default. To enable password protection or change password, just enter your username and password, and click on “Apply Change” button.



The screenshot shows the 'System Configuration' page with the 'Password Settings' section highlighted. The interface includes a navigation menu on the left with options like LAN Interface Setup, Time Settings, Password Settings (selected), System Management, and SNMP Settings. The main content area contains three input fields: 'User Name:', 'New Password:', and 'Confirmed Password:'. Below these fields are two buttons: 'Apply Change' and 'Reset'.

6.5 System Management

System Configuration -> System Management

In this page, administrator can change the management parameters and disable/enable management interface.



The screenshot shows the 'System Management' page. Under the 'CLI' section, there are two checkboxes: 'Enable SSH Daeman' and 'Enable Telnet Daeman', both of which are currently unchecked. Below these are 'Apply Change' and 'Reset' buttons. The 'Public Key Upload' section features a text input field labeled 'Select Public Key File', a file browser icon (labeled '瀏覽...'), and an 'Upload' button.

CLI (Command Line Interface):

You can enable or disable Telnet and SSH management interface from here.

Public Key Upload: You can upload your public for the SSH authentication here.

6.6 Watchdog

System Configuration -> Watchdog

The Ping Watchdog will ping remote IP addresses to make sure the wireless connection is active, if not, it can either reconnect or reboot. To prevent the AP from power recycling, the PING watchdog will start 10 minutes after power up to prevent power recycle problem.



- **Watch Interval:** means: "How often the CPE will PING". For example, it will PING once every "1" minute.
- **Watch Host:** This is the IP address for which the Watchdog will ping.

6.7 Firmware Upgrade

System Configuration -> Firmware Upgrade

You can upgrade the firmware of your AIRMAX2 (the software that controls your AIRMAX2's operation). Normally, this is done when a new version of firmware offers new features that you want, or solves problems that you have encountered with the current version.

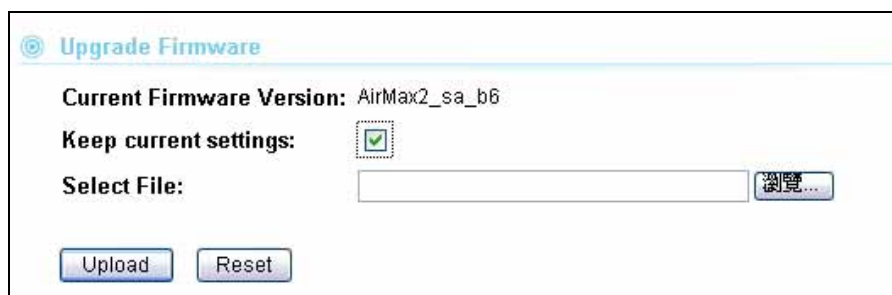

■ Upgrade Firmware:

To update the AIRMAX2 firmware, first download the firmware from AirLive web site to your local disk. Then from the above screen enter the path and filename of the firmware file (or click **Browse** to locate the firmware file). Next, Click the **Upgrade** button to start.

Please make sure to check the “Keep Settings” box if you want the settings to be kept after firmware upgrade.

The new firmware will be loaded to your AIRMAX2. After a message appears telling you that the operation is completed, you need to reset the system to have the new firmware take effect.



Do not power off the device while upgrading the firmware. It is recommended that you do not upgrade your AIRMAX2 unless the new firmware has new features you need or if it has a fix to a problem that you've encountered.

6.8 Configuration Save and Restore

System Configuration -> Configuration Save and Restore

The AIRMAX2 can save and restore the settings to a file. In addition, it has the unique capability to restore only the network or wireless settings. This makes changes of wireless settings across the entire network of AP much easier.

You can save system configuration settings to a file, and later download it back to the AIRMAX2 by following the steps.

Step 1 Select *Configuration Save and Restore* from the *System Configurations* menu.



Step 2 Click on “Save to” and Enter the path of the configuration file to save-to.

Restore Setting:

Step1: Enter the file name in the “Load Settings from File” field. Or click on “Browse” button to location the location of the file.

Step2: Click on “Upload” button to restore settings.

6.9 Factory Default

System Configuration -> Factory Default

You can reset the configuration of your AIRMAX2 to the factory default settings.

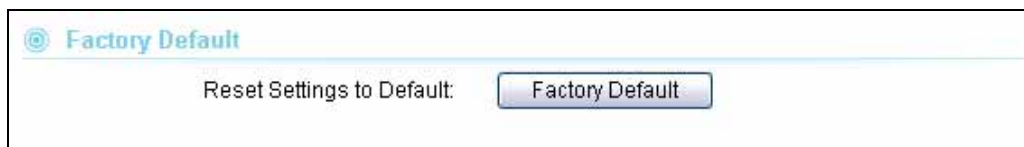

7

Device Status Menu

In this chapter, we will explain the “Device Status” menu in the web management interface. Before you read this chapter, please make sure to read through chapter 3 on “Introduction to Web Management Interface.”

7.1 Menu Structure

When you click on the “Device Status” on the top menu bar, the sub menu for device status will appear.



7.2 Device Information

This page shows the general information about AIRMAX2 such as Uptime, Firmware version, Wireless Interface...etc. Below are some additional explanations on some status information of this page:

- **Uptime:** This displays the time since system last boot up. This is a good indication for how long the system has been alive.
- **Firmware version:** This place will display the current firmware version of your AirMax2. In general, AirLive will refer to its firmware as exx (such as e10) version on the release note
- **Wireless :** This page displays the current settings and status of the radio. It includes the BSSID and connection status. The BSSID is also the wireless MAC address that is needed for the WDS entry.

Wireless	
Mode:	AP
Physical Address:	00:4f:62:93:01:93
Band:	2.4 GHz (B+G)
SSID:	Airmax2
Channel Number:	11
Encryption:	Disabled
Associated Clients:	1
BSSID:	00:4f:62:93:01:93

- LAN Configuration.** This page displays the status of the LAN port such as MAC address, DHCP status.

LAN Configuration	
Connection Method:	Fixed IP
Physical Address:	00:4f:62:93:01:91
IP Address:	192.168.1.1
Network Mask:	255.255.255.0
DHCP Server:	ON
DHCP Start IP Address:	192.168.1.100
DHCP Finish IP Address:	192.168.1.200

- Internet Configuration:** Internet configuration tells you the current status of WAN port such as IP address, WAN Type and connection status.

Internet Configuration	
Connection Method:	PPPoE Connected
Physical Address:	00:4f:62:93:01:92
IP Address:	61.217.146.176
Network Mask:	255.255.255.255
Default Gateway:	61.217.144.254

7.3 Statistic

This page shows the sent and received packet information for Radio1, Radio2, LAN, and WAN interface.

Statistics

Wireless LAN	Sent Packets	2153
	Received Packets	156439
Ethernet LAN	Sent Packets	0
	Received Packets	0
Ethernet WAN	Sent Packets	4968
	Received Packets	22001

Refresh

7.4 Client Table

It will show all wireless device connected to the AIRMAX2. It will show the packet sent and received. Whether the wireless client is using power saving mode and the signal strength level(in percentage from 0 to 100).

Client Table

MAC Address	Tx Packet	Rx Packet	Tx Rate (Mbps)	Power Saving	Signal
00:1a:73:4d:7c:97	1215	1239	54	yes	58
00:4f:62:94:02:14	2	1	54	no	19

Refresh

7.5 Log

The log function is where you can check for error messages for diagnostic purpose.

- **Enable Log:** Check this box to enable log function.
 - **System All:** register all logs
 - **Wireless:** register wireless log only

8

Bandwidth Control

In this chapter, you will learn how to utilize AirMax2's Bandwidth Control function. The Bandwidth Control settings can be found in the "Wireless Settings" page on the AirMax2's web management.

8.1 What is Bandwidth Control?

Bandwidth Control is a great tool to control the bandwidth of the WISP subscribers. Therefore, the WISP operators can offer different class of connection speeds for different subscription fees - just like the ADSL service! The AirLive advance firmware can control the bandwidth by Interface or IP/MAC.



8.2 Type of Bandwidth Control

AirMax2's Bandwidth Control function limits the "Maximum Data Rate". There are 2 types of Bandwidth Control it offers.

8.2.1 Interface Control

The interface QoS controls the data rate at the WLAN and LAN interfaces. Therefore, all traffics are controlled the same way. This type of Bandwidth Control is suitable when AP is used as a Client AP in "Client Mode" and WISP mode. So WISP can control the maximum

data rate



8.2.2 Individual IP/MAC Control

The AP can set the maximum data rate for each IP or MAC addresses. This type of Bandwidth Control is most suitable for outdoor AP in “AP” or “Gateway” mode.

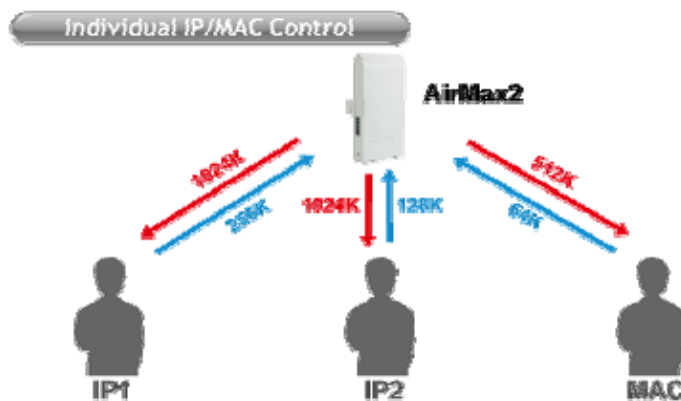

8.3 What is “Out Rate”?

The “Output Rate” is the data speed out of an interface. There are 3 types Output Rate supported by the AP

1. **LAN Output Rate**: This is the speed of the traffic out of the LAN port. In gateway mode, the LAN Output Rate includes both the wired LAN and WLAN interface.
2. **WLAN Output Rate**: This is the speed of the traffic out of the Wireless LAN
3. **WAN Output Rate**: This is the speed of the traffic out of the WAN port. In WISP mode, the WAN Output Rate also includes the WLAN interface.

The AP's Web UI will tell you which types of output rate it supports, it differs in each wireless mode.

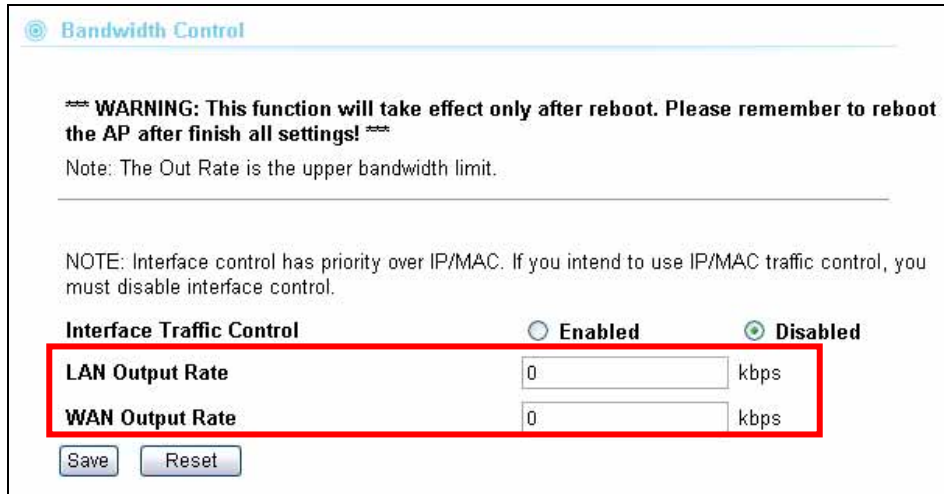

In the below Diagram:

- The AP is in Gateway Mode
- The WAN Output Rate is 128K
- The LAN/WLAN Output Rate is 1024K



In this setup, the notebook users get an upstream bandwidth of 128K and downstream bandwidth of 1024K.

8.4 Configure the Bandwidth Control

From the Wireless Setting page, please choose the "Bandwidth Control"

Once you click on the “setup” button, a new window will pop-up with the Bandwidth Control settings. They are divided into “A”, “B”, “C”, “D” section for further explanations.

1 Interface Traffic Control

2 Policy Name, LAN Out Rate, WAN Out Rate, Comment

3 Enable IP control, Policy Name, IP, LAN Out Rate, WAN Out Rate, Comment

4 Enable MAC control, Policy Name, MAC, LAN Out Rate, WAN Out Rate, Comment

This section is the “Interface Control” session. You must disable the “interface Bandwidth Control” if you want to use the “IP/MAC Bandwidth Control”

This section is for defining the “Policy” of “Individual IP/MAC Bandwidth Control”. Once a policy is defined, it can be chosen as template in IP/MAC Bandwidth Control Settings

This section is to configure the bandwidth by IP address. You can control more than one IP address.

This section is to configure the bandwidth by MAC address. You can control more than one MAC address.

8.4.1 Interface Control Settings

Interface Traffic Control	<input checked="" type="radio"/> Enabled	<input type="radio"/> Disabled
LAN Output Rate	<input type="text" value="512"/>	kbps
WAN Output Rate	<input type="text" value="1024"/>	kbps
<input type="button" value="Save"/> <input type="button" value="Reset"/>		

In the Interface Control Settings, the AP only controls the total bandwidth limit of an interface. For example, if you want to limit the output data rate of the LAN to 512K and the output data rate of WLAN to 1024K. You should perform the following steps:

1. Enable the “Interface Bandwidth Control
2. Enter “512” in the “LAN Output Rate”
3. Enter “1024” in the “WLAN Output Rate”
4. Click on “Save”
5. Reboot the AP.



8.4.2 Define Policy

A policy is a set of bandwidth rules that can be used as a template. For example, if you want to provide 2 kinds of bandwidth speed to the users:



- VIP Subscriber:
 - LAN Out Rate: 512 Kbps
 - WLAN Out Rate: 1024 Kbps
- Regular Subscriber:
 - LAN Out Rate: 64 Kbps
 - WLAN Out Rate: 512 Kbps

You can configure the bandwidth rule as policies “VIP” and “Regular”.

Policy Name	LAN Out Rate	WLAN Out Rate	Comment	
VIP	512 kbps	1024 kbps	VIP Subscriber	
<input type="button" value="Save"/>	<input type="button" value="Reset"/>			
Current Policy Table:				
Policy Name	LAN Rate (Kbps)	WLAN Rate (Kbps)	Comment	Select
VIP	512	1024	VIP Subscriber	<input type="checkbox"/>
Regular	64	512	Regular Subscriber	<input type="checkbox"/>
<input type="button" value="Delete Selected"/>	<input type="button" value="Delete all"/>	<input type="button" value="Reset"/>		

Please follow the step below to create a new policy “VIP”

1. Enter “VIP” for the “PolicyName”
2. Enter “512” for the “LAN Out Rate”
3. Enter “1024” for the “WLAN Out Rate”
4. Enter “VIP Subscriber” for the “Comment”
5. Click on “Save” button
6. Now the “VIP” policy will show up in the “Current Policy Table”

Once finished, the administrator will be able to choose the policy “VIP” for their IP/MAC Bandwidth Control.

8.4.3 Control by IP Address

You can set the maximum bandwidth of a PC or a subscriber by using the IP Control.

Please follow the procedure below to setup IP Bandwidth Control

1. Please make sure the “Interface Bandwidth Control” is disabled
2. Before you start, please check the following area to see which client IPs are supported. It differs between each mode.

Note: Only the Wireless LAN side client IPs are supported. ← Please check this part to find out what IP addresses are supported. It varies between each mode

Enable IP control

Policy Name	IP	LAN Out Rate	WLAN Out Rate	Comment
VIP	192.168.0.250	512 kbps	1024 kbps	Subscriber A

Save Reset

Current IP control table:

Policy Name	IP Addr	LAN Rate (Kbps)	WLAN Rate (Kbps)	Comment	Select
VIP	192.168.0.20	512	1024	Subscriber A	<input type="checkbox"/>

Delete Selected Delete all Reset

3. Enable the IP Control
4. If you have defined a Policy already, please choose a Policy name. The “Out Rates” will be automatically pasted from the Policy template. You cannot change the Out Rates if you have chosen a Policy
5. If you want to define new Data Rate, please do not choose any policies. Then you can enter the values in the “LAN”, “WLAN”, or “WAN” Out Rates.
6. Press “Save” to save settings
7. Reboot your AP.

** If you want to control the traffic flow between the IPs in the same interface, please make sure both IPs are configured for the IP Bandwidth Control.*

8.4.4 Control by MAC Address

You can set the maximum bandwidth of a PC or a subscriber by using the MAC Control.

Please follow the procedure below to setup MAC Bandwidth Control:

1. Please make sure the “Interface Bandwidth Control” is disabled
2. Before you start, please check the following area to see which client MACs are supported. It differs between each mode.
3. Enable the MAC Control

Note: Only the Wireless LAN side client MACs are supported. ← Please check this part to find out what IP addresses are supported. It varies between each mode

Enable MAC control

Policy Name	MAC	LAN Out Rate	WLAN Out Rate	Comment
VIP	004F60111111	512 kbps	1024 kbps	VIP Subscriber

Save Reset

Current MAC control table:

Policy Name	MAC Addr	LAN Rate (Kbps)	WLAN Rate (Kbps)	Comment	Select
VIP	00:4f:60:11:11:11	512	1024	VIP Subscriber	<input type="checkbox"/>

Delete Selected Delete all Reset

4. If you have defined a Policy already, please choose a Policy name. The “Out Rates” will be automatically pasted from the Policy template. You cannot change the Out Rates if you have chosen a Policy
5. If you want to define new Data Rate, please do not choose any policies. Then you can enter the values in the “LAN”, “WLAN”, or “WAN” Out Rates.
6. Press “Save” to save settings
7. Reboot your AP.

** If you want to control the traffic flow between MAC addresses in the same interface, please make sure both MAC addresses are configured for the MAC Bandwidth Control.*

9

Command Line Interface

In this chapter, we will explain commands that are available through Telnet or SSH interface.

Before reading this chapter, please go through Section 3.3 of Chapter 3. It contains information on how to login Telnet or SSH interface. For quick reference, the login and password is as bellowed:

- **Telnet**
 - Password: airlive
- **SSH**
 - Login: admin
 - Password: airlive

9.1 Available Commands

[Mode] Wireless Mode			
sys			
	operation	<0: AP 1: Client 2: Bridge 3: WDS Repeater 4: Universal Repeater 5: WISP 6: WISP+Universal Repeater 7: Gateway>	
[Mode] Basic Settings			
wlan			
	alias	[string]	
	active	[on off]	
	chid	[channel_id auto]	
	essid	[essid]	
	rssid	[rssid]	
	band	[b g bg]	
	mode	[client <infrastructure adhoc>]	
	clone	[mac_addr auto manual]	
	encrypt	[both wlan wan]	
	wds		
		peer	
			disp
			add [mac]
			delete [id]
			clearall
		encrypt	[off]
			wep [64 128] <ascii hex>

			<key>
			wpa [tkip aes] <pass hex> <key> [gklt]
			wpa2 [mixed aes] <pass hex> <key> [gklt]
	stp	[on off]	
	isolation	[on off]	
wlan			
	alias	[string]	
[Mode] Site Survey			
wlan			
	survey		
		connect	[id]
			(only support in Client, WISP, Universal Repeater Mode, WISP + Universal Repeater Mode)
[Mode] Security			
wlan			
	auth	[open share auto]	
	security		
		encrypt	[off]
			wep [64 128] <ascii hex> <1:key1 2:key2 3:key3 4:key4> <key>
			wpa [tkip aes] <pass hex> <key> [gklt]
			wpa2 [mixed aes] <pass hex> <key> [gklt]
		1x	[off on <port> <ip_addr> <password> <wep [64 128] wpa [tkip aes] wpa2 [mixed aes]>]
		preauth	[on off]
		account	[off on <port> <ip_addr> <password>]
[Mode] Advanced Settings			
wlan			wlan
	preamble	[long short]	
	bssid	[on off]	
	iapp	[on off]	
	protect11g	[on off]	
	fragment	<256~2346>	
	rts	<0~2347>	
	beacon	<20~1024>	
	inactivity	<100~60480000>	
	datarate	<0~12>	
	txpower	<1~10>	
	watchdog	[off on <interval: 1~60> <host>]	
[Mode] Access Control			
wlan			
	acl		

		disp	
		off	
		allow	
		deny	
		add [mac]	
		delete [id]	
		clearall	
[Mode] Wan Port			
wan			
	clone	[mac_addr]	
	dns	[auto manual]	
	static	[ip_addr <netmask> <gateway>]	
	dhcp	[on release renew]	
	pppoe	<username> <password> [svname 0 1 <service_name>] <auth_type> <mppe> <mtu_value> dynwan dynpppoe [connect 0 1 <timeout> 2]	
	pptp	<ip [server_ip] url [server_url]> <username> <password> <auth_type> <mppe> <mtu_value> [static <ip_addr> <netmask> <gateway> dynamic]	
	l2tp	<ip [server_ip] url [server_url]> <username> <password> <auth_type> <mppe> <mtu_value> [static <ip_addr> <netmask> <gateway> dynamic] <timeout>	
		auth_type: 0. PAP 1. CHAP 2. MSCHAP 3. MSCHAP2	
		mppe: 0. none 1. 40bits 2. 56bits 3. 128bits	
	link	[status set <mode>]	
	protocol	status	
sys	server	access	icmp <0: disabled 1: enabled>
	passthruvpn	ipsec <0: disabled 1: enabled>	
	passthruvpn	pptp <0: disabled 1: enabled>	
	passthruvpn	l2tp <0: disabled 1: enabled>	
[Mode] Virtual Servers			
ip			
	nat		
		server	
			disp

			delete [id]
			clearall
			add <ser_ip> <server> [proto <from_port [to_port]>]
			server: 0. Customize 1. Web, 2. FTP, 3. POP3, 4. SMTP, 5. DNS, 6. Telnet
			proto: 1. TCP+UDP, 2. TCP, 3. UDP
[Mode] Special Applications			
ip			
	nat		
		service	
			disp
			sap1 [on off clear edit <name> <in_proto> <in_from_port> <in_to_port> <trig_proto> <trig_from_port> <trig_to_port>]
			sap2 [on off clear edit <name> <in_proto> <in_from_port> <in_to_port> <trig_proto> <trig_from_port> <trig_to_port>]
			sap3 [on off clear edit <name> <in_proto> <in_from_port> <in_to_port> <trig_proto> <trig_from_port> <trig_to_port>]
			sap4 [on off clear edit <name> <in_proto> <in_from_port> <in_to_port> <trig_proto> <trig_from_port> <trig_to_port>]
			sap5 [on off clear edit <name> <in_proto> <in_from_port> <in_to_port> <trig_proto> <trig_from_port> <trig_to_port>]
			sap6 [on off clear edit <name> <in_proto> <in_from_port> <in_to_port> <trig_proto>

			<trig_from_port> <trig_to_port>]
			sap7 [on off clear edit <name> <in_proto> <in_from_port> <in_to_port> <trig_proto> <trig_from_port> <trig_to_port>]
			sap8 [on off clear edit <name> <in_proto> <in_from_port> <in_to_port> <trig_proto> <trig_from_port> <trig_to_port>]
			proto: 1. TCP+UDP, 2. TCP, 3. UDP
[Mode] Remote Management			
sys			
	server	access	web <0:disabled 1:enabled>
		port	web <portnum>
		access	telnet <0:disabled 1:enabled>
[Mode] URL Filtering			
ip			
	urlfilter		
		customize	
			disp
			add [string]
			delete [id]
			clearall
[Mode] MAC Filtering			
ip			
	macfilter		
		customize	
			disp
			add [mac_addr]
			delete [id]
			clearall
[Mode] IP Filtering			
ip			
	ipfilter		
		customize	
			disp
			add [ip_addr] <1:tcp+udp 2:tcp 3:udp>
			delete [id]
			clearall
[Mode] Traffic Control(Qos)			
qos			
	disableif		
	enableif	lanoutput [output rate]	

		wanoutput [output rate]	
	addpolicytab	[Policy Name][LAN Out Rate][WAN Out Rate][[Comment]]	
	disableip		
	enableip		
	addiptab	[PolicyName][IP][[Comment]]	
	disablemac		
	enablemac		
	addmactab	[PolicyName][MAC][[Comment]]	
	show	policytab iptab mactab	
	delallpolicy		
	delallip		
	delallmac		
	delpolicy	[Policy]	
	delip	[IP]	
	delmac	[MAC]	
[Mode] DoS Setting			
dos			
	disabledos		
	enabledos		
	enable	<clearall> [Packets/Second] <selectall> [Packets/Second] <sysfloodysyn> [Packets/Second] <sysfloodfin> [Packets/Second] <sysfloodudp> [Packets/Second] <sysfloodicmp> [Packets/Second] <persrcipfloodysyn> [Packets/Second] <persrcipfloodfin> [Packets/Second] <persrcipfloodudp> [Packets/Second] <persrcipfloodicmp> [Packets/Second] <tcpudpportscan> <icmptsmurf> <ipland> <ipspoof> <ipteardrop> <pingofdeath> <tcpscan> <tcpsynwithdata> <udpbomb> <udpechochergen> <srcipblocktime> [sec]	
	disable	<sysfloodysyn> <sysfloodfin> <sysfloodudp> <sysfloodicmp> <persrcipfloodysyn> <persrcipfloodfin> <persrcipfloodudp> <persrcipfloodicmp> <tcpudpportscan> <icmptsmurf> <ipland> <ipspoof> <ipteardrop> <pingofdeath>	

		eath><tcpscan><tcpsynwit hdata><udpbomb><udpech ochargen><srcipblocktime >	
[Mode] Dynamic DNS			
ddns			
	enabledyndns	<Domain Name> <User Name/Email> <Password/Ke y>	
	enabletzo	<Domain Name> <User Name/Email> <Password/Ke y>	
	disableddns		
	result		
[Status] Statistics			
ip			
	status		
[Status] Active Wireless Client Table			
wlan			
	association		
[TCP/IP] LAN Interface Setup			
ip	address	[addr]	
	subnetmask	[netmask]	
	gateway	[addr]	
	dhcp	on	[client server relay <server_ip>]
		off	
		client	
			[start_ip <end_ip>]
		status	
	dns		
		server	
			[ip1 <ip2> <ip3>]
		status	
[Reboot] Reboot System			
reboot			
[Other] Password			
sys			
	password	[pw]	(if [pw] is empty, then clear the password)
[Other] Save / Reload Setting			
save			
factorydefault			
[Other] NTP			
sys			
	ntp		
		showcurrenttime	
		setcurrenttime	<yyyy/mm/dd/hh/MM/ss>
		enablenntp	
		timezoneselect	<zone num>
		ntpserver	<servernum>
			manualipsetting <ip>
		disablenntp	
[Other] System Log			
sys			

	log		
		disable	
		enablesysall	[showsysall]
		enablewlanonly	[showwlanonly]
		clear	

10

Emergency Firmware Recovery

The AIRMAX2 features emergency firmware upgrade function that can restore your AP from a firmware crashed. If you can't access your AP anymore, please first try to restore the setting to default by holding the RESET button (in the back) for more than 10 seconds. You should be able to find the AP at 192.168.1.1. If you can't find it, then please perform the emergency upgrade.

10.1 How Emergency Upgrade Works?

AIRMAX2's flash memory is divided into "firmware" and "bootloader" area. The bootloader area is protected from writing and has a built-in emergency web server. Therefore, the AP can be recovered from emergency web server after a firmware crash. The emergency web server is enabled when AP is forced into emergency upgrade mode, its IP will be changed to **192.168.1.6**.

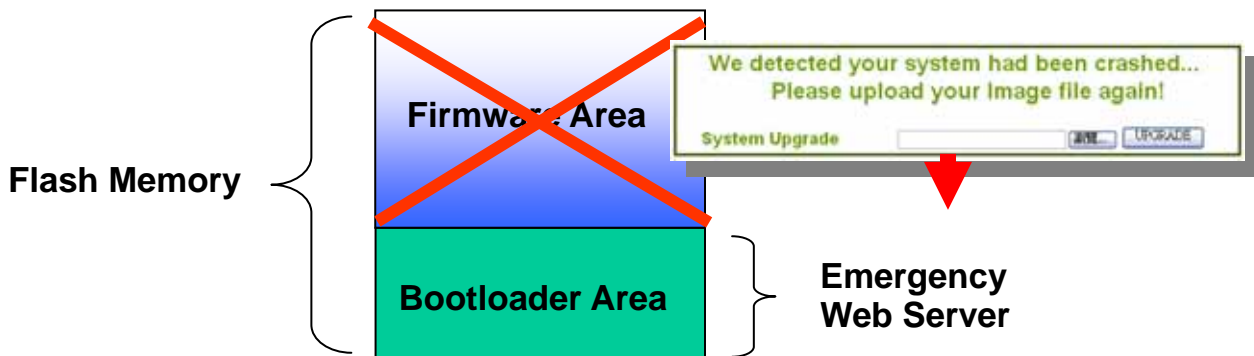

10.2 Emergency Upgrade Procedure

1. Please connect your PC directly to the LAN Port **of AirMax2**
2. set your PC's IP address to 192.168.1.50
3. Before connecting the power, please press and holding the "Reset" button(in the back of the AP). Then plug in the power. Keep press and hold the Reset button until the "Green Color" LED light on(about 2 seconds). Then release the reset button.

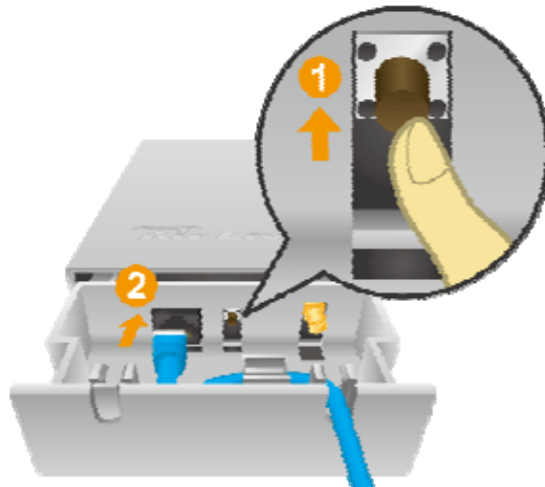

Fig 1-2 : Press and hold the reset button while plugging in the power.

6. Open a browser; type “192.168.1.6” for the website address. The following screen should show up



7. Click the “Browse” button, select and open the correct firmware file. Please go to www.airlive.com to AIRMAX2’s support page and download.
8. Click on “UPGRADE” button. Do not touch the AP or PC until the upgrade is completed.
9. Wait for AP to finish reboot. Open the web browser, and type “192.168.1.254”. You should be able to login into the normal Web UI.

11

Frequent Asked Questions

In this chapter, we will address some frequent asked questions about AirMax2

Question: I forgot my password or the IP address of AirMax2.

Answer: Please restore your settings to default by press the reset button for more than 5 seconds. You should be able to find your AirMax2 at 192.168.1.1 with default username “admin” and password “airlive”.

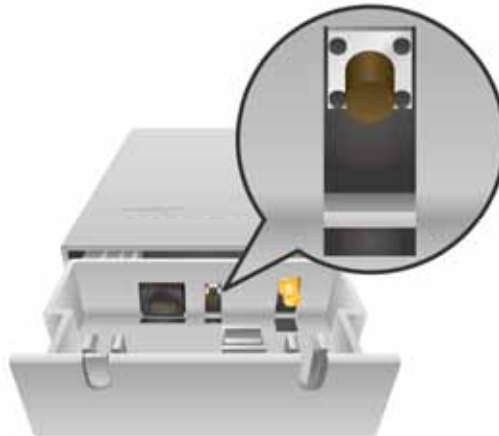

=====
Question: Why is my settings unchanged after pressing the “Apply” button?

Answer: Please reboot your AirMax5 after all the settings are changed.

=====
Question: Where can I purchase the optional metal Mounting Kit?

Answer: The part number for the mounting kit is “WMK-AIRMAX”. Please ask your authorized AirLive distributor for availability.

=====



=====

Question: When I plug in the POE cable and power adapter, the AirMax2's power LED is not on?

Answer: Please make sure you have connected the PoE cable to the correct port on the DC injector. Moreover, you should use an Ethernet cable with 4 twisted pairs (CAT5 or better) for POE cable.

=====

Question: When I use an external antenna, how much distance can the AirMax2 reach?

Answer: The distance of a wireless connection depends on many factors such as cable loss and weather conditions. There is an online distance calculator at the AirLive website. The distance calculated is not a guaranteed value; it is for your reference only. If you agree with this limitation, please visit http://www.airlive.com/support/wireless_distance_calculator.jsp

=====

Question: I tried the Emergency Upgrade procedure. But it doesn't work, why?

Answer: It is recommended to use IE6, IE8, or Firefox 3.5.4 above.

=====

Question: Why can't I receive any signal from AirMax2's built in antenna?

Answer: The AirMax2's built-in antenna is a patch antenna that sends and receive signal in the forward direction of the CPE with 70 degree angle horizontal and 38 degree vertically. Please see diagram below:

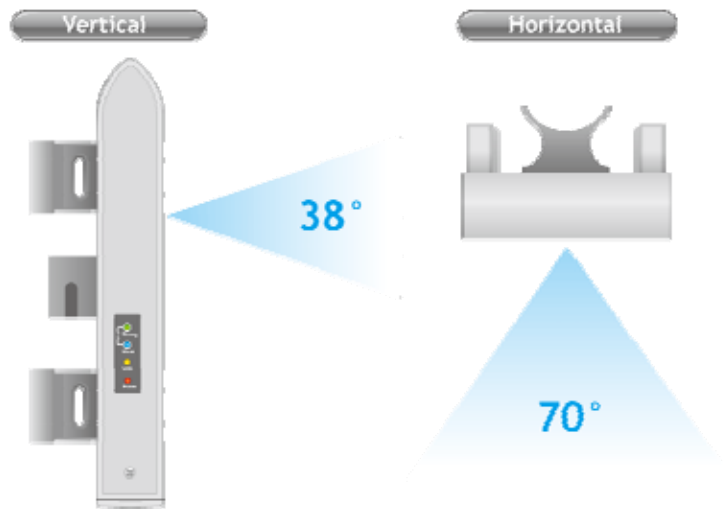

Please also make sure the antenna (*Operation Mode->Setup->Advance Settings*) is **not** set to use external antenna.

Question: Where is the signal survey function that displays the Signal Strength value continuously?

Answer: The “Signal Survey” function is inside the Site Survey function. You can access from “*Wireless Settings -> Site Survey*” menu.

Question: When I use “Site Survey”, why does the Signal LED goes off?

Answer: When you click on the Site Survey, the AirMax2 thinks you are trying to choose a new network to associate. Therefore, it will disconnect from current connection and wait until you establish a new connection.

12

Specifications

The specification of AirMax2 is subject to change without notice. Please use the information with caution.

12.1 Hardware Features

12.1.1 General Hardware Feature

- 802.11g/b Radio
- 4MB Flash, 16MB SDRAM
- RoHS compliant
- One 10/100 Mbps Ethernet Port / PoE Port with Auto MDI/MDI-X support
- 12V Passive PoE
- 26dBm Transmit Output power (20dBm in EU)
- Rain and splash proof housing
- 4 LED indicators with RSSI LED function
- Optional Metal Wall / Pole Mount Kit

12.1.2 Antenna

- Integrated 10 dBi patch directional antenna
- Vertical Polarizations
- R-SMA connector for external antenna
- Software switchable between internal and external antenna
- H-Plane Coverage Angle: 70 degree in the forward direction
- E-Plane Coverage Angle: 38 degree in the forward direction

12.1.3 Power Supply

- Power Adapter Voltage : input 100~240Vac/50~60Hz , output 12V/1A
- Advance Passive PoE (Accept 12 volts)
- POE Adapter, DC Injector provided

12.1.4 Dimension and Weight

- Dimension: 210 x 100 x 32 mm
- Package Weight: 750g

12.2 Radio Specifications

12.2.1 Frequency Band

- USA (FCC) 11 Channels: 2.412GHz~2.462GHz
- Europe (ETSI) 13 Channels : 2.412GHz~2.472GHz
- South America 14 channels: 2.412GHz~2.484GHz

12.2.3 Rate and Modulation

- **Data Rate :** 6, 9, 12, 18, 24, 36, 48, 54Mbps
- **Modulation:**
 - 11g Orthogonal Frequency Division Multiplexing (OFDM)
 - 11b Direct Sequence Spread Spectrum (CCK, DQPSK, DBPSK)

12.2.4 TX Output Power

- 20dBm (ETSI: Europe)
- 23dBm (FCC: United States)
- 26dBm (South America)

12.2.5 Receiver Sensitivity

IEEE 802.11b	Min (dBm)	1Mbps	-95
		2Mbps	-91
		5.5Mbps	-90
		11Mbps	-86
IEEE 802.11g	Min (dBm)	6Mbps	-86
		9Mbps	-86
		12Mbps	-85

		18Mbps	-83
		24Mbps	-81
		36Mbps	-77
		48Mbps	-73
		54Mbps	-71

12.2.6 Supported WLAN Mode

- 802.11g/b Auto
- 802.11g only
- 802.11b only

12.3 Software Feature

12.3.1 Operation Mode

- Access Point Mode (AP mode)
- Client Mode (Infrastructure and Adhoc)
- WDS Bridge Mode
- WDS Repeater Mode
- Universal Repeater Mode
- WISP Router Mode
- WISP + Universal Mode
- AP Router Mode
- WDS Station Mode

12.3.2 Management Interface

- Web HTTP
- Secured Web (HTTPS)
- Telnet (CLI)
- SSH (Secured Shell)



13

Wireless Network Glossary

The wireless network glossary contains explanation or information about common terms used in wireless networking products. Some of information in this glossary might be outdated, please use with caution.

802.3ad

802.3ad is an IEEE standard for bonding or aggregating multiple Ethernet ports into one virtual port (also known as trunking) to increase the bandwidth.

802.3af

This is the PoE (Power over Ethernet) standard by IEEE committee. 803.af uses 48V POE standard that can deliver up to 100 meter distance over Ethernet cable.

802.11b

International standard for wireless networking that operates in the 2.4 GHz frequency band (2.4 GHz to 2.4835 GHz) and provides a throughput up to 11 Mbps.

802.1d STP

Spanning Tree Protocol. It is an algorithm to prevent network from forming. The STP protocol allows net work to provide a redundant link in the event of a link failure. It is advise to turn on this option for multi-link bridge network.

802.11d

Also known as "Global Roaming". 802.11d is a standard for use in countries where systems using other standards in the 802.11 family are not allowed to operate.

802.11e

The IEEE QoS standard for prioritizing traffic of the VoIP and multimedia applications. The WMM is based on a subset of the 802.11e.

**802.11g**

A standard provides a throughput up to 54 Mbps using OFDM technology. It also operates in the 2.4 GHz frequency band as 802.11b. 802.11g devices are backward compatible with 802.11b devices.

802.11i

The IEEE standard for wireless security. 802.11i standard includes TKIP, CCMP, and AES encryption to improve wireless security. It is also known as WPA2.

802.1x

802.1x is a security standard for wired and wireless LANs. In the 802.1x parlance, there are usually supplicants (client), authenticator (switch or AP), and authentication server (radius server) in the network. When a supplicant requests a service, the authenticator will pass the request and wait for the authentication server to grant access and register accounting. The 802.1x is the most widely used method of authentication by WISP.

Adhoc

A Peer-to-Peer wireless network. An Adhoc wireless network does not use wireless AP or router as the central hub of the network. Instead, wireless clients are connected directly to each other. The disadvantage of Adhoc network is the lack of wired interface to Internet connections. It is not recommended for network more than 2 nodes.

Access Point (AP)

The central hub of a wireless LAN network. Access Points have one or more Ethernet ports that can connect devices (such as Internet connection) for sharing. Multi-function Access Point can also function as an Ethernet client, wireless bridge, or repeat signals from other AP. Access Points typically have more wireless functions compared to wireless routers.

ACK Timeout

Acknowledgement Timeout Windows. When a packet is sent out from one wireless station to the other, it will wait for an Acknowledgement frame from the remote station. The station will only wait for a certain amount of time, this time is called the ACK timeout. If the ACK is NOT received within that timeout period then the packet will be re-transmitted resulting in reduced throughput. If the ACK setting is too high then throughput will be lost



due to waiting for the Ack Window to timeout on lost packets. If the ACK setting is too low then the ACK window will have expired and the returning packet will be dropped, greatly lowering throughput. By having the ability to adjust the ACK setting we can effectively optimize the throughput over long distance links. This is especially true for 802.11a and 802.11g networks. Setting the correct ACK timeout value need to consider 3 factors: distance, AP response time, and interference. The AIRMAX2 provide ACK adjustment capability in form of either distance or direct input. When you enter the distance parameter, the AIRMAX2 will automatically calculate the correct ACK timeout value.

Bandwidth Management (Bandwidth Control)

Bandwidth Management controls the transmission speed of a port, user, IP address, and application. Router can use bandwidth control to limit the Internet connection speed of individual IP or Application. It can also guarantee the speed of certain special application or privileged IP address - a crucial feature of QoS (Quality of Service) function.

Bootloader

Bootloader is the under layering program that will start at the power-up before the device loads firmware. It is similar to BIOS on a personal computer. When a firmware crashed, you might be able to recover your device from bootloader.

Bridge

A product that connects 2 different networks that uses the same protocol. Wireless bridges are commonly used to link network across remote buildings. For wireless application, there are 2 types of Bridges. WDS Bridge can be used in Point-to-Point or Point-to-Multipoint topology. Bridge Infrastructure works with AP mode to form a star topology.

Cable and Connector Loss: During wireless design and deployment, it is important to factor in the cable and connector loss. Cable and connector loss will reduce the output power and receiver sensitivity of the radio at connector end. The longer the cable length is, the more the cable loss. Cable loss should be subtracted from the total output power during distance calculation. For example, if the cable and connector loss is 3dBm and the output power is 20dBm; the output power at the cable end is only 17dBm.

Client

Client means a network device or utility that receives service from host or server. A client



device means end user device such as wireless cards or wireless CPE.

CPE Devices

CPE stands for Customer Premises Equipment. A CPE is a device installed on the end user's side to receive network services. For example, on an ADSL network, the ADSL modem/router on the subscriber's home is the CPE device. Wireless CPE means a complete Wireless (usually an AP with built-in Antenna) that receive wireless broadband access from the WISP. The opposite of CPE is CO.

CTS

Clear To Send. A signal sent by a device to indicate that it is ready to receive data.

DDNS

Dynamic Domain Name System. An algorithm that allows the use of dynamic IP address for hosting Internet Server. A DDNS service provides each user account with a domain name. A router with DDNS capability has a built-in DDNS client that updates the IP address information to DDNS service provider whenever there is a change. Therefore, users can build website or other Internet servers even if they don't have fixed IP connection.

DHCP

Dynamic Hosting Configuration Protocol. A protocol that enables a server to dynamically assign IP addresses. When DHCP is used, whenever a computer logs onto the network, it automatically gets an IP address assigned to it by DHCP server. A DHCP server can either be a designated PC on the network or another network device, such as a router.

DMZ

Demilitarized Zone. When a router opens a DMZ port to an internal network device, it opens all the TCP/UDP service ports to this particular device. The feature is used commonly for setting up H.323 VoIP or Multi-Media servers.

DNS

A program that translates URLs to IP addresses by accessing a database maintained on a collection of Internet servers.

**Domain Name**

The unique name that identifies an Internet site. Domain Names always have 2 or more parts, separated by dots. In www.airlive.com, the "airlive.com" is the domain name.

DoS Attack

Denial of Service. A type of network attack that floods the network with useless traffic. Many DoS attacks, such as the Ping of Death and Teardrop attacks, exploit limitations in the TCP/IP protocols.

Encryption

Encoding data to prevent it from being read by unauthorized people. The common wireless encryption schemes are WEP, WPA, and WPA2.

ESSID (SSID)

The identification name of an 802.11 wireless network. Since wireless network has no physical boundary like wired Ethernet network, wireless LAN needs an identifier to distinguish one network from the other. Wireless clients must know the SSID in order to associate with a WLAN network. Hide SSID feature disables SSID broadcast, so users must know the correct SSID in order to join a wireless network.

Firewall

A system that secures a network and prevents access by unauthorized users. Firewalls can be software, router, or gateway. Firewalls can prevent unrestricted access into a network, as well as restricting data from flowing out of a network.

Firmware

The program that runs inside embedded device such as router or AP. Many network devices are firmware upgradeable through web interface or utility program.

FTP

File Transfer Protocol. A standard protocol for sending files between computers over a TCP/IP network and the Internet.



Fragment Threshold

Frame Size larger than this will be divided into smaller fragment. If there are interferences in your area, lower this value can improve the performance. If there are not, keep this parameter at higher value. The default size is 2346. You can try 1500, 1000, or 500 when there are interference around your network.

Gateway

In the global Internet network, the gateways are core routers that connect networks in different IP subnet together. In a LAN environment with an IP sharing router, the gateway is the router. In an office environment, gateway typically is a multi-function device that integrates NAT, firewall, bandwidth management, and other security functions.

Hotspot

A place where you can access Wi-Fi service. The term hotspot has two meanings in wireless deployment. One is the wireless infrastructure deployment, the other is the Internet access billing system. In a hotspot system, a service provider typically need an authentication and account system for billing purposes, and a wireless AP network to provide access for customers.

IGMP Snooping

Internet Group Management Protocol (IGMP) is a Layer 3 protocol to report IP multicast memberships to neighboring multicast switches and routers. IGMP snooping is a feature that allows an Ethernet switch to "listen in" on the IGMP conversation between hosts and routers. A switch support IGMP snooping has the possibility to avoid multicast traffic being treated as broadcast traffic; therefore, reducing the overall traffic on the network.

Infrastructure Mode

A wireless network that is built around one or more access points to provide wireless clients access to wired LAN / Internet service. The opposite of Infrastructure mode is Adhoc mode.

IP address

IP (Internet Protocol) is a layer-3 network protocol that is the basis of all Internet communication. An IP address is 32-bit number that identifies each sender or receiver of information that is sent across the Internet. An IP address has two parts: an identifier of a particular network on the Internet and an identifier of the particular device (which can be a



server or a workstation) within that network. The new IPv6 specification supports 128-bit IP address format.

IPsec

IP Security. A set of protocols developed by the IETF to support secure exchange of packets at the IP layer. IPsec has been deployed widely to implement Virtual Private Networks (VPNs). IPsec supports two encryption modes: Transport and Tunnel. Transport mode encrypts only the data of each packet, but leaves the header untouched. The more secure Tunnel mode encrypts both the header and the payload. On the receiving side, an IPsec-compliant device decrypts each packet.

LACP (802.3ad) Trunking

The 802.3ad Link Aggregation standard defines how to combine the several Ethernet ports into one high-bandwidth port to increase the transmission speed. It is also known as port trunking. Both device must set the trunking feature to work.

MAC

Media Access Control. MAC address provides layer-2 identification for Networking Devices. Each Ethernet device has its own unique address. The first 6 digits are unique for each manufacturer. When a network device have MAC access control feature, only the devices with the approved MAC address can connect with the network.

Mbps

Megabits Per Second. One million bits per second; a unit of measurement for data transmission

MESH

Mesh is an outdoor wireless technology that uses Spanning Tree Protocol (STP) and Wireless Distribution system to achieve self-forming, self-healing, and self-configuring outdoor network. MESH network are able to take the shortest path to a destination that does not have to be in the line of site.

MIMO

Multi In Multi Out. A Smart Antenna technology designed to increase the coverage and performance of a WLAN network. In a MIMO device, 2 or more antennas are used to



increase the receiver sensitivity and to focus available power at intended Rx.

NAT

Network Address Translation. A network algorithm used by Routers to enables several PCs to share single IP address provided by the ISP. The IP that a router gets from the ISP side is called Real IP, the IP assigned to PC under the NAT environment is called Private IP.

Node

A network connection end point, typically a computer.

Packet

A unit of data sent over a network.

Passphrase

Used much like a password, a passphrase simplifies the WEP encryption process by automatically generating the WEP encryption keys for the company products.

POE

Power over Ethernet. A standard to deliver both power and data through one single Ethernet cable (UTP/STP). It allows network device to be installed far away from power ource. A POE system typically compose of 2 main component: DC Injector (Base Unit) and Splitter(Terminal Unit). The DC injector combines the power and data, and the splitter separates the data and power back. A PoE Access Point or CPE has the splitter built-in to the device. The IEEE 802.3af is a POE spec that uses 48 volt to deliver power up to 100 meter distance.

Port

This word has 2 different meaning for networking.

- The hardware connection point on a computer or networking device used for plugging in a cable or an adapter.
- The virtual connection point through which a computer uses a specific application on a server.

**PPPoE**

Point-to-Point Protocol over Ethernet. PPPoE relies on two widely accepted standards: PPP and Ethernet. PPPoE is a specification for connecting the users on an Ethernet to the Internet through a common broadband medium, such as a single DSL line, wireless device or cable modem.

PPTP

Point-to-Point Tunneling Protocol: A VPN protocol developed by PPTP Forum. With PPTP, users can dial in to their corporate network via the Internet. If users require data encryption when using the Windows PPTP client, the remote VPN server must support MPPE (Microsoft Point-To-Point Encryption Protocol) encryption. PPTP is also used by some ISP for user authentication, particularly when pairing with legacy Alcatel / Thomson ADSL modem.

Preamble Type

Preamble are sent with each wireless packet transmit for transmission status. Use the long preamble type for better compatibility. Use the short preamble type for better performance

Rate Control

Ethernet switches' function to control the upstream and downstream speed of an individual port. Rate Control management uses "Flow Control" to limit the speed of a port. Therefore, the Ethernet adapter must also have the flow control enabled. One way to force the adapter's flow control on is to set a port to half-duplex mode.

RADIUS

Remote Authentication Dial-In User Service. An authentication and accounting system used by many Internet Service Providers (ISPs). When you dial in to the ISP, you must enter your username and password. This information is passed to a RADIUS server, which checks that the information is correct, and then authorizes access to the ISP system. Radius typically uses port 1812 and port 1813 for authentication and accounting port. Though not an official standard, the RADIUS specification is maintained by a working group of the IETF.

Receiver Sensitivity

Receiver sensitivity means how sensitive is the radio for receiving signal. In general; the



slower the transmission speed, the more sensitive the radio is. The unit for Receiver Sensitivity is in dB; the lower the absolute value is, the higher the signal strength. For example, -50dB is higher than -80dB.

RJ-45

Standard connectors for Twisted Pair copper cable used in Ethernet networks. Although they look similar to standard RJ-11 telephone connectors, RJ-45 connectors can have up to eight wires, whereas telephone connectors have only four.

Router

An IP sharing router is a device that allows multiple PCs to share one single broadband connection using NAT technology. A wireless router is a device that combines the functions of wireless Access Point and the IP sharing router.

SIGNAL STRENGTH

Receiver Sensitivity Index. SIGNAL STRENGTH is a value to show the Receiver Sensitivity of the remote wireless device. In general, remote APs with stronger signal will display higher SIGNAL STRENGTH values. For SIGNAL STRENGTH value, the smaller the absolute value is, the stronger the signal. For example, "-50db" has stronger signal than "-80dB". For outdoor connection, signal stronger than -60dB is considered as a good connection.

RTS

Request To Send. A packet sent when a computer has data to transmit. The computer will wait for a CTS (Clear To Send) message before sending data.

RTS Threshold

RTS (Request to Send). The RTS/CTS(clear to send) packet will be send before a frame if the packet frame is larger than this value. Lower this value can improve the performance if there are many clients in your network. You can try 1500, 1000 or 500 when there are many clients in your AP's network.

SNMP

Simple Network Management Protocol. A set of protocols for managing complex networks. The SNMP network contains 3 key elements: managed devices, agents, and network-management systems (NMSs). Managed devices are network devices that content SNMP agents. SNMP agents are programs that reside SNMP capable device's



firmware to provide SNMP configuration service. The NMS typically is a PC based software such as HP Openview that can view and manage SNMP network device remotely.

SSH

Developed by SSH Communications Security Ltd., Secure Shell is a program to log into another computer over a network, to execute commands in a remote machine, and to move files from one machine to another. It provides strong authentication and secure communications over insecure channels. It is a replacement for rlogin, rsh, rcp, and rdist.

SSL

Secure Sockets Layer. It is a popular encryption scheme used by many online retail and banking sites to protect the financial integrity of transactions. When an SSL session begins, the server sends its public key to the browser. The browser then sends a randomly generated secret key back to the server in order to have a secret key exchange for that session. SSL VPN is also known as Web VPN. The HTTPS and SSH management interface use SSL for data encryption.

Subnet Mask

An address code mask that determines the size of the network. An IP subnet are determined by performing a BIT-wise AND operation between the IP address and the subnet mask. By changing the subnet mask, you can change the scope and size of a network.

Subnetwork or Subnet

Found in larger networks, these smaller networks are used to simplify addressing between numerous computers. Subnets connect to the central network through a router, hub or gateway. Each individual wireless LAN will probably use the same subnet for all the local computers it talks to.

TCP

A layer-4 protocol used along with the IP to send data between computers over the Internet. While IP takes care of handling the actual delivery of the data, TCP takes care of keeping track of the packets that a message is divided into for efficient routing through the Internet.

**TX Output Power**

Transmit Output Power. The TX output power means the transmission output power of the radio. Normally, the TX output power level limit for 2.4GHz 11g/b is 20dBm at the antenna end. The output power limit for 5GHz 802.11a is 30dBm at the antenna end..

UDP

User Datagram Protocol. A layer-4 network protocol for transmitting data that does not require acknowledgement from the recipient of the data.

Upgrade

To replace existing software or firmware with a newer version.

Upload

To send a file to the Internet or network device.

URL

Uniform Resource Locator. The address of a file located on the Internet.

VPN

Virtual Private Network. A type of technology designed to increase the security of information transferred over the Internet. VPN creates a private encrypted tunnel from the end user's computer, through the local wireless network, through the Internet, all the way to the corporate network.

WAN

Wide Area Network. A communication system of connecting PCs and other computing devices across a large local, regional, national or international geographic area. A WAN port on the network device means the port (or wireless connection) that is connected to the Internet side of the network topology.

WEP

Wired Equivalent Privacy. A wireless encryption protocol. WEP is available in 40-bit (64-bit), 108-bit (128-bit) or 152-bit (Atheros proprietary) encryption modes.

**Wi-Fi**

Wireless Fidelity. An interoperability certification for wireless local area network (LAN) products based on the IEEE 802.11 standards. The governing body for Wi-Fi is called Wi-Fi Alliance (also known as WECA).

WiMAX

Worldwide Interoperability for Microwave Access. A Wireless Metropolitan Network technology that complies with IEEE 802.16 and ETSI Hiperman standards. The original 802.16 standard call for operating frequency of 10 to 66Ghz spectrum. The 802.16a amendment extends the original standard into spectrum between 2 and 11 Ghz. 802.16d increase data rates to between 40 and 70 Mbps/s and add support for MIMO antennas, QoS, and multiple polling technologies. 802.16e adds mobility features, narrower bandwidth (a max of 5 mhz), slower speed and smaller antennas. Mobility is allowed up to 40 mph.

WDS

Wireless Distribution System. WDS defines how multiple wireless Access Point or Wireless Router can connect together to form one single wireless network without using wired uplinks. WDS associate each other by MAC address, each device

WLAN

Wireless Local Area Network. A type of local-area network that uses high-frequency radio waves rather than wires to communicate between nodes. The most popular standard for WLAN is the 802.11 standards.

WMM

Wi-Fi Multimedia (WMM) is a standard to prioritize traffic for multimedia applications. The WMM prioritize traffic\ on Voice-over-IP (VoIP), audio, video, and streaming media as well as traditional IP data over the AP.

WMS

Wireless Management System. An utility program to manage multiple wireless AP/Bridges.

**WPA**

Wi-Fi Protected Access. It is an encryption standard proposed by WiFi for advance protection by utilizing a password key (TKIP) or certificate. It is more secure than WEP encryption. The WPA-PSK utilizes pre-share key for encryption/authentication.

WPA2

Wi-Fi Protected Access 2. WPA2 is also known as 802.11i. It improves on the WPA security with CCMP and AES encryption. The WPA2 is backward compatible with WPA. WPA2-PSK utilizes pre-share key for encryption/authentication.