

AirLive Technology

2025 Network Innovations



www.airlive.com ISO 9001

About AirLive

At AirLive, we stand as a distinguished network brand and solution provider headquartered in Taiwan, bringing over 25 years expertise in IT networking and communication field. Our commitment revolves around delivering not just individual network device, but comprehensive solutions that drive excellence. AirLive products represent brilliant value for Enterprise Corporate solutions, Business professionals, Operator, Small business, Industrial applications.

Moreover, AirLive set up trustable cooperation with business partner. Each project takes cautions consulting evaluation together, offering technical online or onsite training, business meeting, and visiting project case.



AirLive Core Value

Professional team

AirLive – An professional and creative team, continuously upgrading new innovations and solutions to contribute best value.

High-quality Quaranty

Always produce and supply high-quality reliable network and communications products.

Market acumen

Keep attention in market and technology trend and demands, upgrade and enhance up our solution to launch new products and to meet customer needs on time.

Trust and Long-term close partnership

Maintain good and long-term trust relationships with our customers; setting up open and frequent communications.

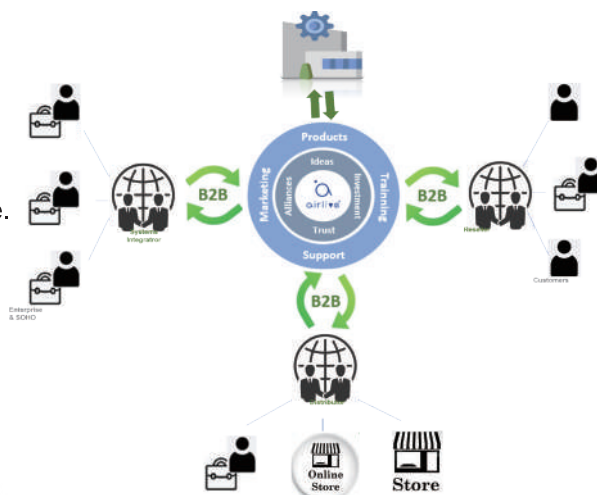

Technology

AirLive latest Innovations 2025

AI powered innovations and high-speed edge products are more important in today's technology and life.

AirLive is proud to present significant upgrades across all our product lines which meet the revolution trend – delivering faster performance, smarter technology, and greater efficiency for modern networks.



Solutions



Broadband Pon Solution FTTX

EMS Cloud
Optical Fiber
10G XGS OLT & ONU

Wired Connectivity Network Switches

100G Core Switch
10G & 2.5G Base-T
L3/WEB Smart/PnP
802.3bt PoE++

AircloudI Wireless Central Management

AirCloud
2.4G/5G/6Ghz
Triple bands
10Gbps

Aircam AI Powered Enterprise Surveillance

Smart AI Powered
Smart Auto Swift-Dual Light
Auto Focus Motorized

AirLive 10G and 2.5G Base-T & Fiber Switch

AirLive upgraded 10G and 2.5G switches with the latest circuit and chipsets that breaks performance bottlenecks at a much more affordable price; create a reliable high-speed backbone, increase data transmission and processing capabilities, reduce traffic congestion, and relieve pressure on the system. From Unmanaged, Web smart, Layer 3, to Data Center Core switch; AirLive supplies comprehensive 10G and 2.5G switches which satisfy various applications.

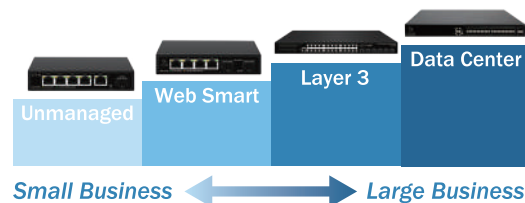

AirLive 10GE & 2.5GE Switch Advantages

- Auto-negotiation 1G/2.5G/5G/10G
- 4K/8K Media Streaming
- Lag-Free Gaming
- Enhanced Scalability
- Ideal for NAS/Server/PC/Gaming
- Multiple Models Layer 3 to Plug-and-Play
- With 802.3bt 90w PoE for Wi-Fi 7 AP and modern IoT device
- Future-Proofing

AirLive 10G Base-T & Fiber Switch

AirLive model no.	L3D-10XGF26-100GF	L3-10XGF12 WEB-10XGF12	L3-10TX804 WEB-10TX804	L3-10TX701 WEB-10TX701	L3-10TX408 WEB-10TX408	WEB-10XGF8 Live-10XGF8	WEB-10TX402 Live-10TX402	WEB-10TX800 Live-10TX800	WEB-10TX5 Live-10TX5	L3POE-10TX804-260 BT	L3POE-10TX701-280 BT
Ports	24 x 10G SFP+ 2 x 100G QSFP28 (able to split to 4x25G)	12 x 10G SFP+	8 x 10G RJ45 4 x 10G SFP+	7 x 10G RJ45 1 x 10G SFP+	4 x 10G RJ45 8 x 10G SFP+	8 x 10G SFP+	4 x 10G RJ45 2 x 10G SFP+	8 x 10G RJ45	5 x 10G RJ45	8 x 10G RJ45 (P1~P4:90W) 4 x 10G SFP+	7 x 10G RJ45 (P1~P7:90W) 1 x 10G SFP+
Switching capacity (Bandwidth)	880Gbps	240Gbps	240Gbps	160Gbps	240Gbps	160Gbps	120Gbps	160Gbps	100Gbps	240Gbps	160Gbps
Forwarding rate	476Mpps	178.56Mpps	178.56Mpps	119.04Mpps	178.56Mpps	119.04Mpps	89.28Mpps	119.04Mpps	74.4Mpps	178.56Mpps	119.04Mpps
MAC Address	96K	32K	32K	16K	32K	16K	16K	16K	16K	32K	16K
Power Supply	2 x AC100~240VAC C (redundant)	AC 100~240VAC					12V2.5A Adapter	AC 100~240VAC	12V2A Adapter	AC 100~240VAC	
Application	Enterprise Campus, Data Center	Enterprise, SMB				SMB	SMB, Home				



L3D-10XGF26-100GF



L3/WEB-10TX408
L3/WEB-10TX402



WEB-10TX800
Live-10TX800



L3POE-10TX701

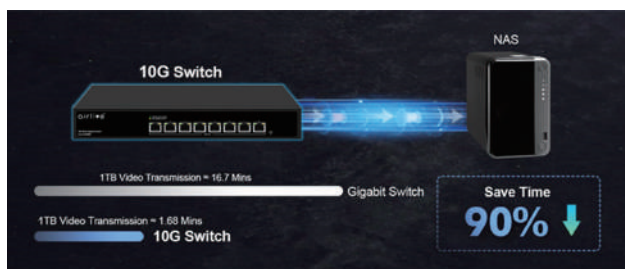

L3/WEB-10XGF12
WEB/Live-10XGF8



L3POE-10TX804

Technology

MULTI GIGA SWITCH

10G | 2.5G Family



unmanaged

web smart

layer 3

10G / 2.5G Key Applications

- Enterprise networks
- Data centers
- Storage area networks
- High-performance computing clusters
- Cloud Computing
- Media and Entertainment
- Healthcare
- Finance Services
- Online Gaming
- Education

2.5 Times Faster



Works with existing cables



AirLive 2.5G Base-T & Fiber Switch

AirLive model no.	L3D-2TX4806-40GF	L3-2TX2406	WEB-2TX2402	Live-2TX1602D 2TX2402D	WEB-2TX801 Live-2TX801	WEB-2TX501 Live-2TX501	WEB-2TX402 Live-2TX402	L3POE-2TX2406 450 BT	POE-2TX801 100W	POE-2TX411 -65	POE-2TX402 -65
Ports	48 x 2.5G RJ45 4 x 10G/25G SFP28 2 x 40G QSFP+ (able to split to 4x10G)	24 x 2.5GE 6 x 10G SFP+	24 x 2.5GE 2 x 10G SFP+	16 or 24 x 2.5GE 2 x 10G SFP+	8 x 2.5GE 1 x 10G SFP+	5 x 2.5GE 1 x 10G SFP+	4 x 2.5GE 2 x 10G SFP+	24 x 2.5GE (P1~P4:90W) 6 x 10G SFP+ 450W PoE	8 x 2.5GE (P1~P8:30W) 1 x 10G SFP+ 100W PoE	5x 2.5GE (P1~P4:30W) 1 x 10G SFP+ 65W PoE	4 x 2.5GE (P1~P4:30W) 2 x 10G SFP+ 65W PoE
Switching capacity (Bandwidth)	600Gbps	240Gbps	160Gbps	120Gbps	60Gbps	45Gbps	60Gbps	240Gbps	60Gbps	45Gbps	60Gbps
Forwarding rate	446Mpps	178.56Mpps	119.04Mpps	89.28Mpps	44.64Mpps	33.48Mpps	44.64Mpps	178.56Mpps	44.64Mpps	33.48Mpps	44.64Mpps
MAC Address	96K	32K	16K	16K	4K	4K	4K	32K	4K	4K	4K
Power Supply	AC 100~240VAC				12V1A Adapter			AC 100~240VAC			
Application	Enterprise Campus, Data Center, SMB	Enterprise SMB	SMB	SMB	SMB, Home			Enterprise SMB	SMB, Home		



L3D-2TX4806-40GF



WEB-2TX2402
Live-2TX2402



L3-2TX2406



L3POE-2TX2406POE



WEB-2TX402
WEB-2TX501
WEB-2TX801



Live-2TX402
Live-2TX801
Live-2TX501



POE-2TX402
POE-2TX801

AirLive Enterprise Campus Data Center Core Switch







The AirLive Enterprise Campus Core Switch series supports flexible Ethernet and Fiber connections from 2.5G RJ45 to full 100G QSFP28 for scalability of high-density ports; ideal for Enterprise, Data Centers, and large network users like campus. Combining advantages of zero packet loss, low latency, and non-blocking performance for lossless Ethernet.



The Core switch incorporates rich L2~L4 features, including EVPN-VXLAN, MLAG, VRRP, OSFP etc. Software Stacking and link aggregation as well as break-cable scalable and flexible design, redundant hot-swappable power supplies and fans.

			
<p>L3D-2TX4806-40GF: 54-Port L3 2.5G Multi Giga Core Switch including 6-Port Fiber Uplink (40G &10G/25G)</p> <p>54-Port 2.5G RJ-45 include 4 x 10/25G SFP28 & 2 x 40G QSFP+</p> <p>54-port Datacenter Switch L3 CLI Management</p> <p>2.5G RJ-45 10/25G SFP28 40G QSFP+ MLAG</p> <p>VxLAN VRRP</p>	<p>L3D-100XGF32-100GF:32-Port L3 100G Fiber Core switch</p> <p>32-Port 100G QSFP28</p> <p>32-port Datacenter Switch L3 CLI Management</p> <p>100G QSFP28 MLAG VxLAN VRRP</p> <p>Redundant Power Smart Fan</p>	<p>L3D-25XGF56-100GF:56-Port L3 25G Fiber Core switch including 8-Port 100G QSFP28</p> <p>56-Port 25G SFP28 include 8 x 100G QSFP28</p> <p>56-port Datacenter Switch L3 CLI Management</p> <p>25G SFP28 100G QSFP28 MLAG VxLAN</p> <p>VRRP Redundant Power Smart Fan</p>	<p>L3D-10XGF26-100GF: 28-Port L3 10G Fiber Core switch including 2-Port 100G QSFP28</p> <p>26-Port 10G SFP+ include 2 x 100G QSFP28</p> <p>26-port Datacenter Switch L3 CLI Management</p> <p>10G SFP+ 100G QSFP28 MLAG VxLAN</p> <p>VRRP Redundant Power Smart Fan</p>

Enterprise and SMB L3 Gigabit switch

			
<p>L3-XGF28: L3 28-port Managed Gigabit Fiber Switch with 10G uplink</p>	<p>L3POE-XGS4804-850 BT: Layer 3 850W Managed Gigabit PoE+ Switch with 10G uplink</p>	<p>L3POE-XGS4804-400 BT: Layer 3 400W Managed Gigabit PoE+ Switch with 10G uplink</p>	<p>L3POE-XGS2404-400: Managed Gigabit PoE+ Switch with 10G Uplink</p>
			
<p>L3-XGS4804: L3 Managed Gigabit Switch with 10G uplink</p>	<p>L3-XGS2404: L3 Managed Gigabit Switch with 10G uplink</p>		

Technology

AirCloud Wireless Solution

You can set up, configure, monitor, and manage certain Airlive devices around the clock, 24/7, anywhere or centrally, using AirLive cloud-based remote network management – AirCloud.

This unified remote management solution helps cut costs and save time. AirCloud family includes a full range of Access points, in-wall APs, outdoor CPEs, Wi-Fi 7 to Wi-Fi 4, and mobile hotspots through AirCloud, provides a comprehensive network ecosystem.

Key Functions of AirCloud

- ✓ Free Cloud
- ✓ Centralized Management
- ✓ Automated Configuration
- ✓ Real-time Network Monitoring
- ✓ Guest Access Portal capable
- ✓ Security features include Advance Encryption protocols, Firewall Protection, Rogue Access Point Detection



Live Status Monitoring

Flexible and Scalable Wireless Deployment

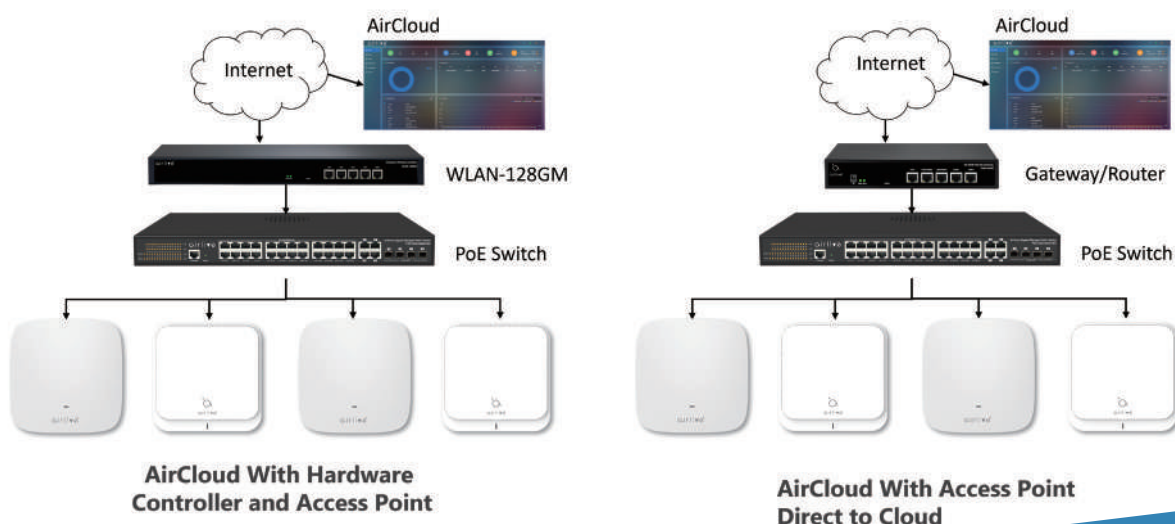

AirCloud *Seamless Connectivity*

Wi-Fi 7 10Gbps Triple bands AP

Wireless and Wired Speed at 10Gbps

AirCloud TOP-100BE and TOP90BE supports the latest Wi-Fi 7 technology with Triple bands 2.4GHz + 5GHz + 6GHz at 10Gbps or 9Gbps wireless speed. Moreover, it is equipped with a 10Gbps or 2.5Gbps 802.3bt PoE++ embedded WAN port, 2.5G LAN port, and one 10Gbps SFP+ for fiber connectivity. It ensures best performance and wireless security encryption.



Ultra Fast 10Gbps Wi-Fi 7 Tri-band (2.4/5/6GHz) Access Point

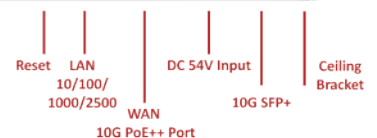

Great Features Wi-Fi 7 Embedded

320MHz Channels & 4K QAM

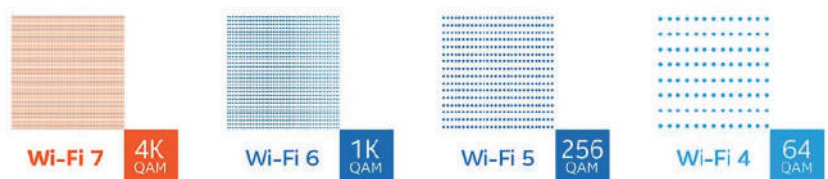

Multiple-Link Operation (MLO) Tri-Bands

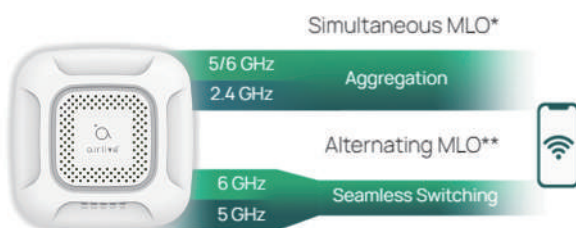

Multi Resource Units (RU) and Puncturing

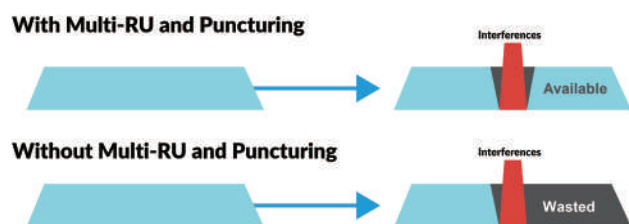

Technology



AirCloud

Wireless ACCESS POINT

Expand your reach. Reliable and robust connectivity, wherever you need it.



AirCloud Wireless (hardware) Controller

AirLive WLAN-64GM/128GM wireless controller provides centralized management, configuration, and monitoring of AirCloud AP's up to 128 or 64AP, allowing for seamless and efficient wireless network operations.



AirCloud Wi-Fi 6 & Wi-Fi 5 AP

AirCloud offers a complete range of indoor Ceiling AP or Inwall AP as well as outdoor CPE to offer stable and easy management wireless connectivity. From latest Wi-Fi 7 to Wi-Fi 4, you have the solution.



AirCloud TOP-30AX-2.5G: Wi-Fi 6 AX3000 Multi Giga PoE Access Point

AirCloud TOP-30AX-1G

AirCloud TOP-12AC: Wave2 MU-MIMO AC1200 Gigabit Access Point

AirCloud inWall-U630AX: Wi-Fi 6 AX 3000 Gigabit in-Wall PoE Access Point



AWOD-30AXI-2.5GE: Wi-Fi 6 AX3000 AirMax5X-AC9: Wi-Fi 5 5Ghz AC900 Outdoor Omni AP

AWOD-12ACi: Wi-Fi 5 AC1200 Outdoor Omni AP

Telecom 10G PON and Cloud Solution

Seamless Fiber Communication, FTTH

A standout offering from AirLive is the Telecom Cloud Solution, focusing on XGS-PON OLT and ONU. This series is designed to empower the next generation of network infrastructure through cloud computing for seamless communication.



Empower Your Network with AirLive's 10G XGSPON OLT Solution Applications

- ✓ Free EMS OLT Cloud
- ✓ Scalable
- ✓ 10Gbps High-Speed
- ✓ Standard-Compliant Optical Line Terminal
- Fiber-to-the-Home (FTTH) deployments
- Enterprise network backbones
- Triple-play services (data, voice, video)
- Municipal and utility network infrastructures

Scalable, High Speed, and Standards-Compliant Telecom Optical Network Development

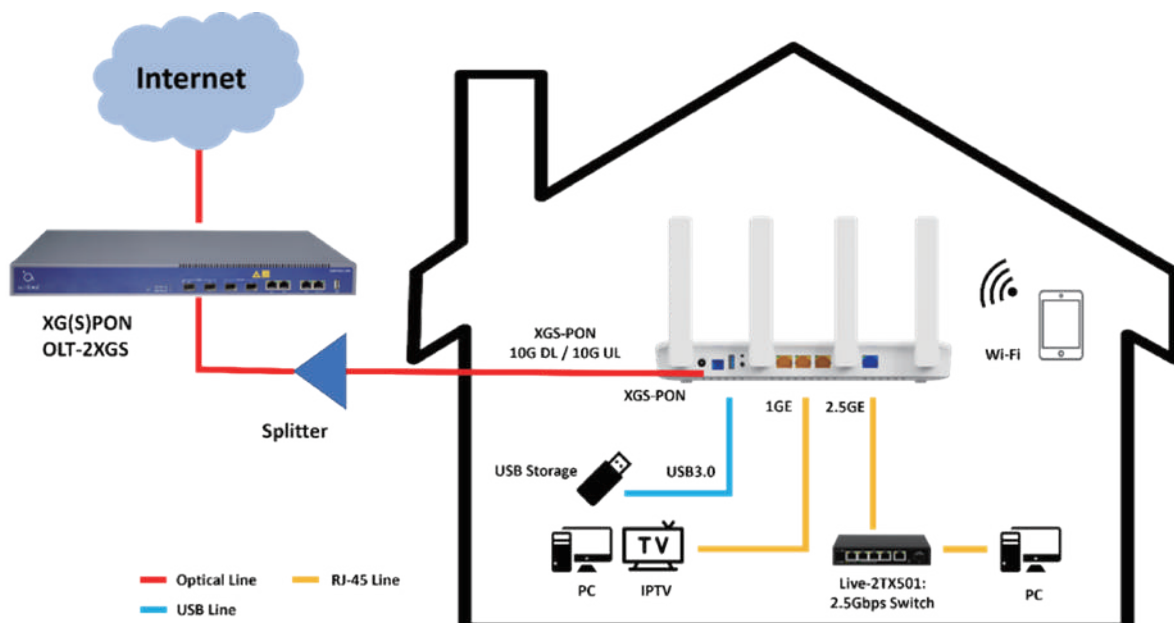

Technology

Major FTTX PON OLT and ONU

AirLive OLT-2XGS

2-port XGS OLT with 2 x 10Gbps XGS PON, 2 x 10G SFP+

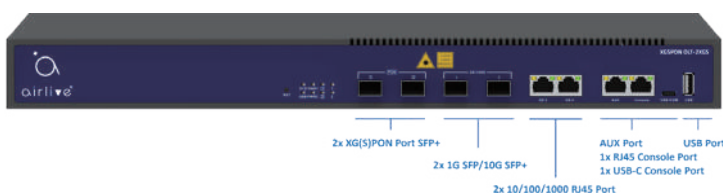

- 2 x 10Gbps PON Module for up to 256 ONU, support 512 ONU upon PON-module for 256 ONU available
- Download/Upload Speed: 10Gbps
- Redundant Power Design
- 2 x 10G SFP+, 2*GE RJ45
- Comes with PON modul

AirLive OLT-2XGS-WDM

2-port XGS OLT with 10Gbps XGS PON, 2 x 10G SFP+, WDM1r embedded
– Merge GPON and XGS or XG PON seamlessly

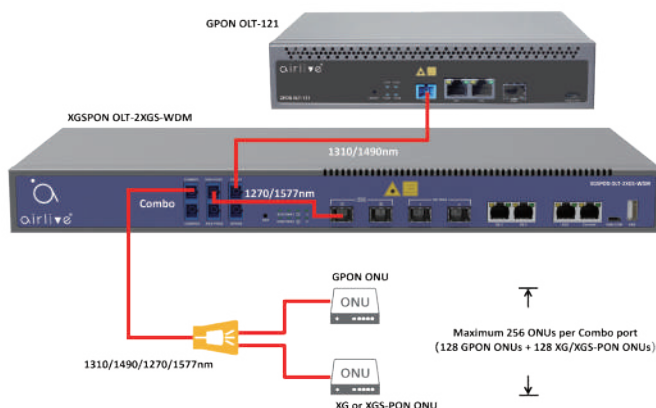

- 2 x 10Gbps PON Module for up to 256ONU, support 512ONU upon PON-module for 256ONU available
- Download/Upload Speed: up to 10Gbps
- Redundant Power Design
- 2 x 10G SFP+, 2*GE RJ45
- Comes with PON Module
- Built-in WDMr
 - 2 x GPON input ports
 - 2 x XG(S)-PON input ports
 - 2 x Combo Output ports (Max 256 ONU per Combo port)
 - 128GPON + 128 XG(s)PON

AirLive OLT-121

1-port GPON OLT with GPON Module built-in, 1 x 10G SFP+



- 1 x GPON OLT with GPON Module integrated for up to 128ONU
- Download/Upload Speed: 2.5Gbps/1.25Gbps
- Redundant Power Design
- 1 x 10G SFP+, 2*GE RJ45

AirLive ONU (GPON, XGS-PON ONU)



ONU-10XGS-AX304-2.5G



ONU-10XGS-1004-10G



XPON 2.5GE XPON ONU

AirCAM



Next-Generation AI Video Analytics

- Empowering security systems with real-time AI precision
- Designed for perimeter defense, behavior detection, and facial recognition
- Seamless integration with existing NVR/CCTV infrastructure



Smart AI

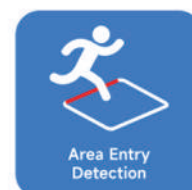
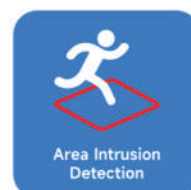
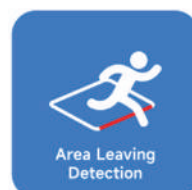
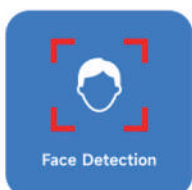

Technology

AirCAM *GET A Sharp Clear Image*

Smart Hybrid Dual-Light

The AirLive AirCam Hybrid Dual-light series IPCAM is equipped with both IR and Warm Light LEDs.

This feature makes that the camera can detect and work automatically in three different modes; Smart Dual Light, Pure Infrared Light and Pure White Light.

Applications

- ✓ Flexible Illumination Modes
- ✓ Reduced Light Pollution
- ✓ Enhanced Security Smart Detection
- ✓ Remote Management
- ✓ Reduced NVR recording space



IR LED ON
In the absence of a vehicle or person, the camera uses only IR light.



White LED ON
When a **Vehicle or Human Body** is detected, white light is automatically triggered on, resulting in color imaging and video with clear details.



IR LED ON
Once the vehicle or human leaves, the camera switches back to IR light automatically.

Smart Motorized Camera – Auto Focus and Digital Zoom

The Motorized lens series AirCAM is equipped with a versatile 2.7-13.5mm or wider range motorized autofocus lens. This feature ensures precise focus adjustments, allowing for sharp and clear imagery without manual intervention.

Enjoy effortless control over your surveillance, capturing every detail with ease and accuracy. Zoom in onto points of interest with the 5x Optical zoom.

More functions / features

- ✓ Motorized Lens or F1.0 2.8mm fixed lens for wide and clear view in option
- ✓ AirCAM VMS & APP supported
- ✓ Built-in MIC & Speaker and Siren alarm in option
- ✓ Industrial grade Water-Proof solid design
- ✓ Sony advance technology
- ✓ NDAA Compliant

AirCAM

AI
Powered

Real-time
Remote
Monitoring

Dual Monitor
Support

Smart &
Efficient
Search

AI-Powered Surveillance Security



ANVR-4/8/16/32

- ** ANVR 4/8/16/32CH for SMB; retail; shops/stores;
- ** 64/128CH ANVR project option
- ** PoE Support in option



Model	EYDL-630AI	EYDL-830AI	EYDL-630AI-MS	EYDL-830AI-MS	EYDL-630AI-RBMS	EYDL-830AI-RBMS	EYDL-640XMAI-MS	EYDL-840XMAI-MS
Resolution	25fps@6MP (3072*2048)	20fps@8MP (3840*2160)	25fps@6MP (3072*2048)	20fps@8MP (3840*2160)	25fps@6MP (3072*2048)	20fps@8MP (3840*2160)	25fps@6MP (3072*2048)	20fps@8MP (3840*2160)
IR Distance	30 Meters	30 Meters	30 Meters	30 Meters	30 Meters	30 Meters	40 Meters	40 Meters
Lens	F1.0 2.8mm	F1.0 2.8mm	F1.0 2.8mm	F1.0 2.8mm	F1.0 2.8mm	F1.0 2.8mm	2.7-13.5mm Motorized Lens	2.7-13.5mm Motorized Lens
Built-in Mic+ Speaker	No	No	Yes	Yes	Yes	Yes	Yes	Yes
SD Slot	No	No	512G	512G	512G	512G	512G	512G
Siren Light	No	No	No	No	Yes	Yes	No	No
AI Function	AI Function: Human Body & Vehicle Detection; Cross Line, Intrusion, Enter Area, Leave Area, Face Detection							



Model	BUDL-630AI	BUDL-830AI	BUDL-630SAI	BUDL-830SAI	BUDL-630AI-MS	BUDL-830AI-MS	BUDL-620AI-RBMS	BUDL-820AI-RBMS	BUDL-640MAI-MS	BUDL-840MAI-MS
Resolution	25fps@6MP (3072*2048)	20fps@8MP (3840*2160)	25fps@6MP (3072*2048)	20fps@8MP (3840*2160)	25fps@6MP (3072*2048)	20fps@8MP (3840*2160)	25fps@6MP (3072*2048)	20fps@8MP (3840*2160)	25fps@6MP (3072*2048)	20fps@8MP (3840*2160)
IR Distance	30 Meters	30 Meters	30 Meters	30 Meters	30 Meters	30 Meters	20 Meters	20 Meters	40 Meters	40 Meters
Lens	F1.0 2.8mm Lens	F1.0 2.8mm Lens	F1.0 2.8mm Lens	F1.0 2.8mm Lens	F1.0 2.8mm Lens	F1.0 2.8mm Lens	F1.0 2.8mm Lens	F1.0 2.8mm Lens	2.7-13.5mm Motorized	2.7-13.5mm Motorized
Built-in Mic and Speaker	No	No	No	No	Yes	Yes	Yes	Yes	No	No
AI Function	Human Body & Vehicle Detection; Cross Line, Intrusion, Enter Area, Leave Area, Face Detection									

Technology

Reliable and Revolutionary with AirLive

The Exploration of Connected World

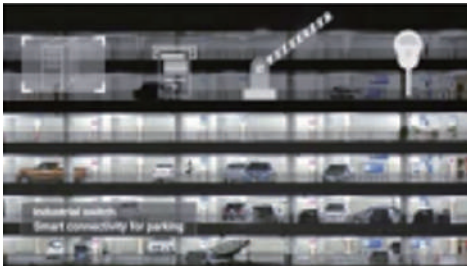

Smart Parking

Industrial Switch stands for wider temperature



Smart Organization

Auto Topology networking and Camera Streaming



Smart Environment

Industrial Serial to LTE reliable data communication



Smart Factory

Ultra fast network recovering with Industrial Ring technology



Smart Hotel

Auto Topology networking and Wi-Fi Access



Smart Energy

Industrial Voltage Boost and PoE Power solution



Smart Factory

Multiple Ring and Chain Work with any network Topology



Smart Security

PoE or Industrial Connectivity



Smart Transportation

Industrial grade LTE and GPS Location solution

AirLive Technology Corp.
 Web: www.airlive.com
 E-mail: info@airlive.com
 HQ: 7F., No.120, Ln235, Baoqiao Rd.,
 Xindian Distr., New Taipei City, 231, Taiwan

Information and Disclaimer

AirLive Technology Corp. has made the best effort to ensure the accuracies of this guide.
 All information is subject to change without notice.
 All trademarks and trade names are properties of their respective holders.
 V.0510.25 ©2025 AirLive Technology Corp. All Rights Reserved



airlive®

Wi-Fi 7

Cloud / Triple Bands

10Gbps

High Speed

Wireless & Wired



Seamless Connectivity

10G Super Speed

10G/9G Wireless Speed
10G/2/5G Base-T
10G SFP+
802.3bt PoE++

Triple Bands

2.4Ghz + 5Ghz
+ 6Ghz

Air Cloud

Free License Cloud
Any time, Anywhere